

OVER 390 NEW ITEMS!

All items marked **NEW!** became available in aftermarket for 2022.

ISSUE #13

2023 CATALOG OF

AFTERMARKET REPLACEMENT PARTS

FOR MOWERS,
CRIMPERS, HAYBINES®,
RAKES, CORN HEADS,
& HARVESTERS

New Holland® and Haybine® are Registered Trademarks of CNH Industrial America LLC which does not manufacture or endorse these parts.

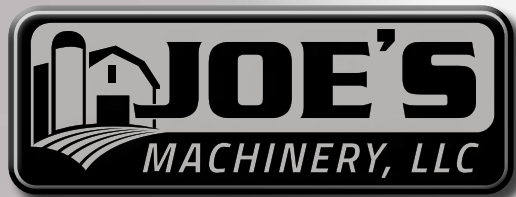

717.464.1043

259 Radcliff Rd. » Willow Street, PA 17584



DEALERS WELCOME! » Please Use Our Part Number & Description When Placing Your Order

Large Inventory » Daily UPS Shipping » Our Goals are Quality & Service!

OUR GOALS ARE QUALITY & SERVICE!

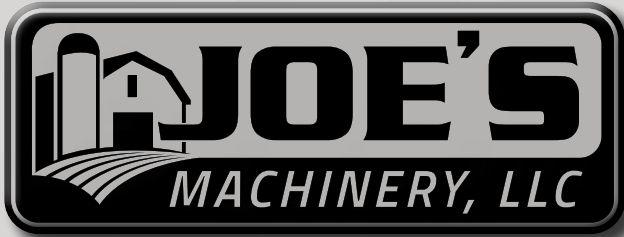

TERMS AND CONDITIONS

You Cannot Order Parts Online!

To order parts:

- **Phone** **717-464-1043**
- **Fax** **717-208-3263**
- **Mail** (our business location) ... **259 Radcliff Road, Willow Street, PA 17584**

Business Hours:

6:00 am to 5:00 pm Monday through Friday. Closed Saturday, Sunday, and all major holidays.

Prices are subject to change without notice.

Shipping

Parts will be shipped by UPS, Truck Freight, US Postal Service or 9 - 5.

Warranty

Joe's Machinery LLC will warrant our product if it is a manufacturing defect. No warranties apply to crop failure or crop loss relating to defects on our aftermarket parts. We will replace and reship as we see fit.

We are concentrating on manufacturing an aftermarket replacement product for older New Holland equipment that is just as good as, if not better than, the original! If you cannot find what you need in our catalog, please give us a call!

Our main product line in aftermarket replacement parts is for the following products:

Mowers - NH 450, 451, 455, 456

Hay Rakes - NH 55, 56, 256, 258, 259, 260

Harvesters - NH 717, 718, 770, 782, 890, 892, 900, FP 230, FP 240

Crimpers - NH 402

Parts for all models of pull type haybines

Corn Heads - NH 824 and 360

We recondition and repaint any of these models that you have.

We accept all major credit cards.

Have your credit card available when ordering.

A 4% processing fee will be added to all credit card orders.

Please have the following information ready when phoning in an order:

part numbers, name, address, and phone number.

This speeds up the processing of your order and improves accuracy.

OUR STORY

We started Joe's Machinery in the year 2000. Mostly we were doing small repair jobs and custom welding. In 2001, we started buying and selling farm equipment. In 2003, we made our first aftermarket parts. In 2004, we sold our cows and moved off the farm to our current location. In 2005, we started doing hi-moisture corn grinding and bagging. In 2006, we built our first hi-moisture corn bagger.

In 2009, we created our first aftermarket parts catalog. In 2010, we built our first combo silage bagger. Also, that same year, we built an addition to the shop. In 2013, we built our first conveyor bagger. That same year, we added more storage room and a paint room, and enlarged our driveway. In 2018, we renovated the shop area for more production in manufacturing aftermarket replacement parts for New Holland equipment. Also, our bagging business turned into a full-time crew being our doing custom silage and hi-moisture bagging from the middle of August to late October.

We now manufacture only the conveyor bagger that has very high capacity and is designed to keep up with a 12-row chopper. We have a dealer set up in Wisconsin to cover all states from Chicago, IL to the western shore of the US. The business name is Nortec. You may contact them at:

Nortec

Phone: 715-623-6300

Website: www.NortecUSA.net

This dealer is only set up for sales of the conveyor bagger.

You can find us on the web by looking up: Lancaster Farming Joe's Machinery

We thank you for your business and look forward to serving you!

From all of us at Joe's Machinery

AFTERMARKET REPLACEMENT PARTS

We manufacture aftermarket replacement parts for all this New Holland® equipment. We ship parts by UPS, truck freight, 9-5, and US mail. Call for delivery options on larger equipment.



Case IH® and New Holland® are Registered Trademarks of CNH Industrial America LLC which does not manufacture or endorse these parts.

AFTERMARKET REPLACEMENT PARTS PRODUCTS INDEX

PRODUCT	PAGES
NH 451, 456 Aftermarket Replacement Mower Parts	3-13
NH 450, 455 Aftermarket Replacement Mower Parts	14
NH 402 Aftermarket Replacement Crimper Parts	15-17
Aftermarket Replacement NH Haybine® Parts	18-29
NH 56, 256, 258, 260 Aftermarket Replacement Rake Parts	30-38
NH 55 Aftermarket Replacement Rake Parts	39-42
NH 824 Aftermarket Replacement Corn Head Parts	43-53
360, 3PN Aftermarket Replacement Corn Head Parts	54-60
NH 790W, 890W, 900W, 990W, 27P, 29P Aftermarket Replacement Hay Head Parts	61-62
NH 717, 718 Aftermarket Replacement Harvester Parts	63-69
NH782, 790 Aftermarket Replacement Harvester Parts	70-81
Chopper Length of Cut Charts	82
NH880, 1800, 1900 Aftermarket Replacement Harvester Parts	83
NH890, 892 Aftermarket Replacement Harvester Parts	84-98
Ag Choice Applicator	98
NH Aftermarket Chopper Tables and Accessories	99
Aftermarket Table Sprockets and Adaptors	100
NH900 Aftermarket Replacement Harvester Parts	101-112
NHFP 230, FP240 Aftermarket Replacement Harvester Parts	113-116
NH Harvester Aftermarket Replacement Goosenecks and Parts	116-117
Equipment and Safety Decals	117-119
USA Links – Connectors and Offsets	120
Timken Drives USA Roller Chain	121
Screens	122
Bearings, Races, and Oil Seals	123-128
Horning Crop Processor	129
Horning Crop Processor - Operating Instructions and Troubleshooting	130-131
Horning Processor Aftermarket Replacement Parts	132-137
Aftermarket Replacement Chopper PTOs and Parts	138-141
Mechanical Transplanters	142
Mechanical Transplanters – Adjustments and Troubleshooting	143-144
Plant Setting Charts	145
Mechanical Transplanter Parts	146-153
NH Rola Bar Rakes	154
NH 790 Harvester	155
NH 892 Harvester with Feed Table	156
NH456 Mower	157
New Holland Haylage Choppers	158
Hi-moisture Bagger Rates and Tonnage Chart	159
New Style Tandem Rake Hitch	160
Tandem Rake Hitches	161
Red Star Bale Spears and Parts	162
Red Star Bagger	163-166
Part Number Index	167-176
Equipment Production Dates Chart	Inside Back Cover

NH 451, 456 » AFTERMARKET REPLACEMENT MOWER PARTS

New Holland® is a Registered Trademark of CNH Industrial America LLC which does not manufacture or endorse these parts.

PART NUMBER	DESCRIPTION	PRICE		
JM100	1¼ Breakaway Pin Uses nut #JM888	\$18.88	 JM888	 JM101
JM101	1⅝ Breakaway Pin Uses nut #JM888	\$18.50	 JM888	 JM101
JM116311	Slotted Nut	\$3.40		
JM127033	Pivot Weld Assembly Uses pivot weld bolt JM280293	\$65.00		
JM127037	3 Pt Mower Cable – Short for 450 and 451 Mowers	\$42.00		
JM127042	Mower Cable – Long for 455 and 456 Mowers	\$42.00		
JM127042A	Mower Cable Bushing	\$12.27		
JM127610	Knife Head Bushing	\$26.20		
JM132027	Pin Goes into bottom of JM9617871	\$18.35		
JM143615	Clamp For steel dividing board	\$10.95		
JM143616	Grass Rod For steel dividing board	\$25.35		
JM143617	Grass Rod For steel dividing board	\$31.06		
JM172197	Crimper Hitch on Mower	\$385.80		
JM172208	Outer Wear Shoe	\$22.40		
JM172438	Eye	\$27.56		
JM174232	9' Bar Support	\$48.62		
JM178677	Breakaway Arm Uses nut #888	\$74.85		

PRICES SUBJECT TO CHANGE WITHOUT NOTICE

717.464.1043

PART NUMBER	DESCRIPTION	PRICE		
JMFF 2014	Mower Guard with raised ledger (double heat treated)	\$21.82		
JM218	DH Mower Guard (double heat treated) This is the highest quality guard built in the aftermarket!	\$14.70		
JM228430	9' Knife Back To bolt your blades to	\$55.61		
JM228431	7' Knife Back To bolt your blades to	\$48.00		
JM244271	Bottom Mower Part (inner shoe assembly) (used only)	\$300.00		
JM244273	Outer Shoe Assembly, Always With ledger plate installed	\$135.97		
JM258452	9' Bar	\$767.47		
JM258454	7' Bar	\$733.70		
JM26616	Wear Plate Use 9 pc. for 7 ft. bar. Use 11 pc. for 9 ft. bar.	\$5.83	<i>Top of the line wear-resistant!</i>	
JM280293	Pivot Bolt Goes with JM127033	\$5.87		
JM280667	Tilt Lok Bolt Goes with JM63752	\$2.25		
JM29875	Under Serrated Sections NEW!	\$1.98		
JM36723T	Timken Race (LM67010) (Goes with 67048 bearing)	\$5.28		
JM36723C	China Race (LM67010)	\$3.47		

PRICES SUBJECT TO CHANGE WITHOUT NOTICE

PART NUMBER	DESCRIPTION	PRICE		
JM36726T	Timken Bearing (LM67048)	\$10.88		
JM36726C	China Bearing (LM67048)	\$3.60		
	Used on many NH farm equipment applications, hay rake gearboxes and wheel housings, Farmbilt 6-lug hub assembly (outer), also 6-lug Amish built forecarts (outer) or wagons, 824 corn heads, NH harvesters and so much more!			
JM36951	Aftermarket Replacement Bushing <i>Like original quality</i> Goes into JM692916	\$7.50		
JM39665	RH Ledger Plate (with 1 long and 1 short bolt)	\$18.09		
JM36989	J-Bolt Rocker	\$9.00		
JM38391	Dividing Board Spring	\$15.44		
JM392	Modified Shaft (uses C75 pulley)	\$135.20		
JM455 456	Head Conversion Kit Kit to convert your head from 455 to 456	\$960.00		
JM456	Head Bearing-Races Kit Includes crankshaft bearings and seal.	\$259.98		
JM456PA	Push Arch only for replacement on push bar assemblies. We have the jig to install it for you!	\$97.52		
JM46876	Aftermarket Replacement Oil Seal Goes with JM392 into housing	\$7.25		
JM63725	Pin Hitch NEW!	\$6.27		
JM63752	Push Bar Tilt Lock	\$14.71		

PRICES SUBJECT TO CHANGE WITHOUT NOTICE

717.464.1043

PART NUMBER	DESCRIPTION	PRICE		
JM63753	Straight Hay Guide Rod (top)	\$9.03		
JM63762	J-Bolt for Pulley Tightener Belt	\$14.45		
JM63771	Clevis Weld Assembly with nut welded in	\$25.19		
JM63777	Eye Bolt Assembly with Clevis	\$38.07		
JM63777A	Clevis with Pin	\$11.45		
JM63800	Ball Pivot	\$105.93		
JM63815	Spring Nut Goes into large lift spring	\$147.98		
JM63828	Pin	\$5.64		
JM63867	Swath Board Part For steel dividing board	\$19.44		
JM63869	LH Ledger Plate (with 2 long bolts)	\$21.79		
JM63871	Bent Hay Guide Rod (bottom)	\$12.14		
JM63881	Front Head Frame	\$132.35		
JM63881A	Frame Pin Only	\$8.95		
JM63904A	Aftermarket Replacement Bushing Goes into JM127025	\$18.13		
JM63905	Clamp For steel dividing board	\$13.87		
JM64126	Cable Pulley with Bushing	\$25.43		

PRICES SUBJECT TO CHANGE WITHOUT NOTICE

PART NUMBER	DESCRIPTION	PRICE	
JM64126A	Old Style Cable Bushing NEW!	\$2.63	
JM64127	New Style Cable Bushing NEW!	\$2.22	
JM64353	Pin Goes with JM65518	\$9.78	
JM65518	Link Assembly	\$34.50	
JM65705	Rod for Mower Spring NEW!	\$8.75	
JM65804	Rear Pulley Shield	\$23.42	
JM65845	Shield Weld Assembly	\$27.50	
JM692916	Push Bar Assembly with Bushing More heavy-duty than the original	\$556.99	
JM692917	Link Weld Assembly	\$55.05	
JM8000	Guard Bolts and Nuts (pack for 9' bar)	\$23.87	
JM8001	Guard Bolts and Nuts (pack for 7' bar)	\$19.64	
JM8001A	7/16 x 1 1/2 Plow Bolt and Nut 7/16 x 1 3/4 Plow Bolt and Nut	\$0.48 each	
JM8002	C45-0040 Adjustable Hold Down Lets you adjust your hold down snug to blade for better mowing <i>We are upgrading the quality of our hold downs and wear plates!</i>	\$7.40	

PRICES SUBJECT TO CHANGE WITHOUT NOTICE

717.464.1043

PART NUMBER	DESCRIPTION	PRICE	
JM8003	Complete 9' Bar Rebuild Kit – Specify Knife (Includes 20 Shims)	\$648.78	
JM8004	Complete 7' Bar Rebuild Kit – Specify Knife (Includes 20 Shims)	\$550.58	
JM8005	SF 1¾ Pulley Bushing Goes with C75 pulley	\$36.30	
JM8006	C75 Pulley Is used on rear of mower for the C96 or C93 Belt Goes on JM392	\$102.28	
JM8007	JM Mower - Wood Dividing Board	\$66.00	
JM8008	Mower - Steel Dividing Board	\$112.65	
JM8009	2 x 8 Lift Cylinder This cylinder is used on most farm equipment	\$142.56	
JM8010	5 Gallon Gas Tanks For your mower or any equipment	\$184.00	
JM8010A	5 Gallon Gas Tanks side mount for BZ Clutches	\$184.00	
JM80100	Mower Pulley Bolt 5/8x7 GR8 NEW!	\$3.77	
JM8011	29 HP Vanguard with BZ Belt Clutch with Hydraulics	Call for Price	[PHOTO NOT AVAILABLE]
JM8012	BZ Belt Clutch Only	\$1,250.00	
JM8012A	29 HP Vanguard	Call for Price	
JM8012B	35 HP Vanguard	Call for Price	
JM8012C	Vanguard Mufflers are extra	Call for Price	

PRICES SUBJECT TO CHANGE WITHOUT NOTICE

PART NUMBER	DESCRIPTION	PRICE		
JM8013	C96 Belt for Mower Drive	\$63.06		
JM8014	C95 Belt for Mower Drive	\$61.06		
JM8015	C93 Belt for Mower Drive	\$59.06		
JM8016	Complete New Mower Frame	\$918.42		
JM8016A	6x28x6 Lug Wheels	\$163.35 each		
JM8017	Honda Engine with Belt Clutch with Hydraulics Bolts onto any mower frame you have	Call for Price		
JM8017A	Joel King Hydraulic Pump LH or RH	\$270.00		
JM80101	Hydraulic Filter for Pump	\$15.02		
JM80102	Hydraulic Filter Head for Pump	\$17.95		
JM8018	Hydraulic Hoses and Hydraulics (done to your specifications) We mount and install hydraulic systems on any farm equipment.	Call with your needs.		
JM8019	Mower Torsion Axle Call for right hand or left hand side. Takes solid shock out of mower. No welding required. Just bolt it on! Comes with 4 bolt hub.	\$311.82 Each		
JM65234	Mower Spindle only	\$43.60		
JM8020	Ledger Plate Bolt and Nut Only	\$1.75 each		

PRICES SUBJECT TO CHANGE WITHOUT NOTICE

717.464.1043

REFERENCE	PART NUMBER	QTY	DESCRIPTION	PRICE
1	JM65548	1	HOUSING – Support Housing Assy., Includes Ref. 2 & 3	\$279.00
2	JM36723T	1	BEARING CUP – Timken LM67010	\$5.28
3	JM86516467	1	BEARING CUP – Timken LM48510	\$8.69
4	JM172396	1	CRANKSHAFT – Assy., Includes Ref. 5	\$318.20
5	JM172397	1	PIN – 24.5mm OD x 100.01mm L-Crank Pin (Can be pressed in or heat shrunk)	\$48.19
6	JM86052	1	ROLLER BEARING – with Built-on Oil Seal LM48500 LA Timken	\$27.13
7	JM36726T	1	BEARING CONE – LM67048 Timken	\$10.88
8	JM181991	1	OIL SEAL	\$8.16
9	JM67437	1	SLOTTED NUT	\$44.20
10	JM280462	1	PIN – 1/8" x 2", Coiled	\$0.95
11	JM130585	1	PULLEY – Sheave Assy., Includes Ref. 10 - Pin	\$236.77
12	JM86541779	1	WASHER – 0.53" ID x 1.31" OD x 0.24" Thk. – 1/2" ID x 1/4" Thk.	\$1.80
13	JM80679	1	LOCK WASHER – 1/20.507 CST ZND – Washer, Lock, 1/2"	\$0.33
14	JM88338	1	BOLT – Hex 1/2" - 20x 1 1/2", GR 5-Screw Cap, HH, G5	\$0.32
15	JM63843	2	SHIM – .010" Thk.	\$1.05
16	JM63881	1	PLATE – Support Plate Weld Assy., Front	\$132.33
	JM280420	2	CARRIAGE BOLTS – Sq. Nk, 1/2" - 13 x 1 1/2", Gr 5, Full Trd. - Bolt, Carriage, G5, 1/2'-13 x 1 1/2'	\$0.81
	JM80679	2	LOCK WASHER – 1/20.507CST ZND – Washer, Lock, 1/2"	\$0.33
	JM280431	2	NUT – 1/2" - 13, G5	\$0.32
17	JM63848	1	SHIM – .010" Thk.	\$3.15
20	JM88182	1	COTTER PIN – 1/4" OD x 2" L-Pin, Split (Cotter), 1/4" x 2"	\$0.55
21	JM784859	1	PLATE – Rear	\$114.27
22	JM784858	1	PLATE – Front	\$61.83
23	JM172391	2	PIN – Weld Assembly	\$46.75
23a	JM86729275	4	LOCK WASHER – 5/8" ID x 0.634" OD x .156" Thk. - Washer, Lock, 5/8"	\$0.30
23b	JM408	4	NUT – 5/8" - 18, Gr 5- G5, 5/8"-18	\$0.34
24	JM172433	10	SHIELD	\$2.90
25	JM36725T	10	BEARING CUP – LM11910 Timken	\$3.96
26	JM36724T	10	BEARING CONE – LM11949 Timken	\$8.79
27	JM172395	2	CONNECTING LINK – Link, Pivot	\$90.65
	JM87415	4	LUBE NIPPLE – 90 Degree, 1/4" NPT x 3/4" L, Drive - Nipple	\$1.00
28	JM87313	5	JAM NUT – 3/4" x 16	\$1.33
29	JM172434	2	BUSHING	\$3.26
30	JM143517	3	WHEEL NUT – Wheel, 3/4"-16	\$10.06
31	JM172390	1	CONNECTING LINK	\$94.35
	JM87569	2	LUBE NIPPLE - 45 Degree, 1/4" NPT	\$1.57
32	JM132709	2	BEARING CUP – L44610 Timken	\$8.65
33	JM132710	2	BEARING CONE – L44643 Timken	\$11.75
34	JM767247	2	SHIELD	\$4.75
35	JM603373	1	JAM NUT – Slotted, 1" - 14, Gr 2-	\$4.13
36	JM80754	1	COTTER PIN – 3/16" OD x 1 1/2" OAL - Pin, Split	\$0.60
37	JM88849	1	BOLT – Hex, 1/2" - 20 x 3", Gr 5-Screw, Cap	\$1.70
	JM80679	1	LOCK WASHER – WASHER, LOCK, 1/2"	\$0.33
	JM208963	1	NUT – Nut, 1/2-20 GR 5 ZND	\$0.53

PRICES SUBJECT TO CHANGE WITHOUT NOTICE

REFER- ENCE	PART NUMBER	QTY	DESCRIPTION	PRICE
38	JM605205	1	WEDGE, DRIVE LOCK	\$6.53
39	JM172204	1	SHIELD	\$15.82
	JM87363	1	WASHER – 0.47" ID x 0.92" OD x 0.07" Thk. – SAE, 7/16"	\$0.47
	JM80756	1	COTTER PIN – 1/8" x 3/4" – PIN, SPLIT (COTTER)	\$0.35
40	JM29790	1	NUT – 1/2" – 20- Hub Bolt	\$2.11
41	JM127025	1	SUPPORT ASSEMBLY – with JM63904 Bushing	\$160.75

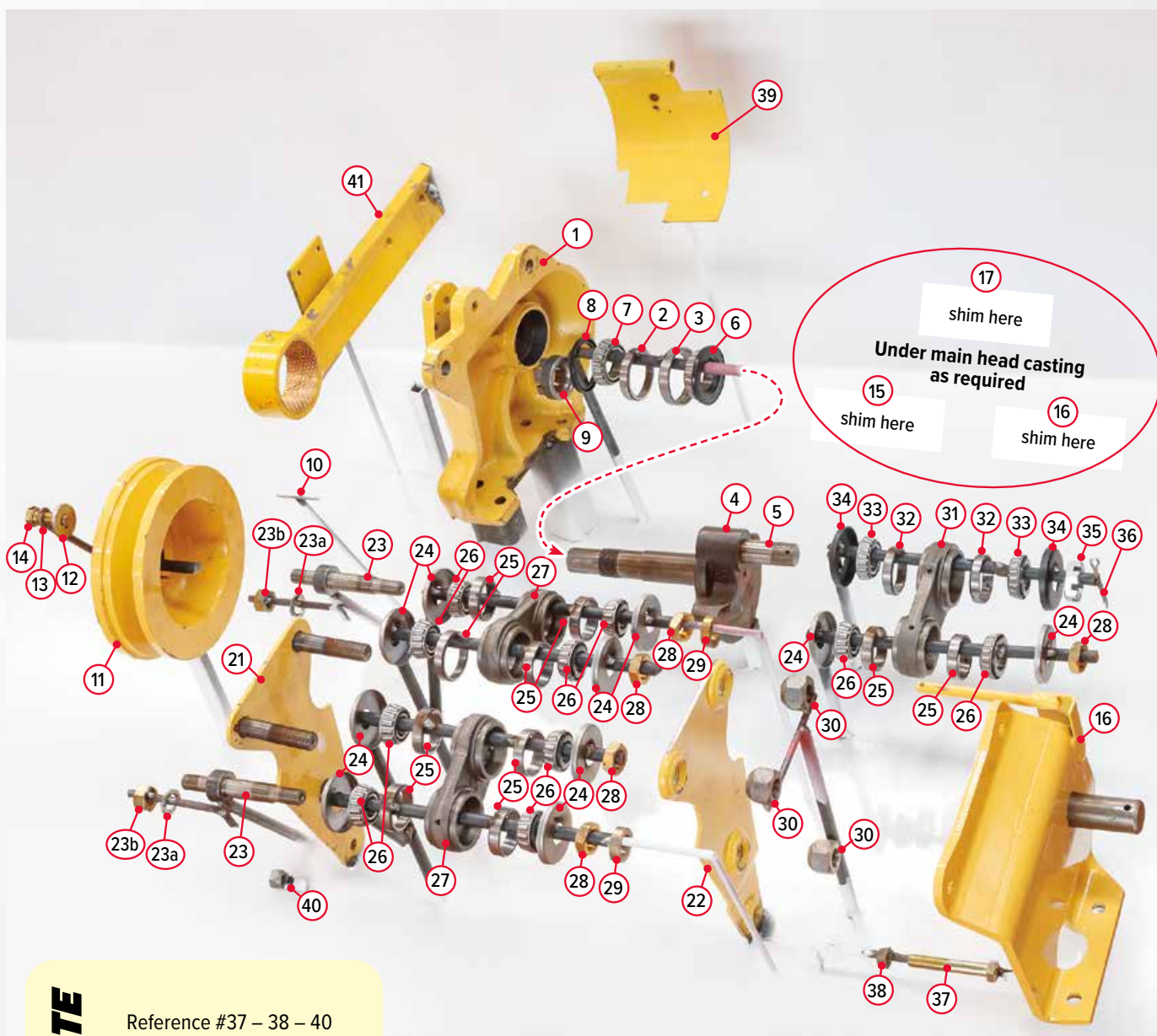

NOTE

Reference #37 – 38 – 40
These are the
Knife Bolt – Nut – Cone

PRICES SUBJECT TO CHANGE WITHOUT NOTICE

717.464.1043

PART NUMBER	DESCRIPTION	PRICE		
JM8021	JMH15-0677 Knife Head Double Blade with Bushing	\$72.00		
JM8022	DS Knife Blade Bolts Enough for a 9 ft. bar.	\$30.94		
JM8023	JM Seven Enough for a 7 ft. bar.	\$29.50		
JM8023AB	Bolt Only – Specify length 5/8" - 1" - 1 1/4"	\$0.15		
JM8023BN	Nut Only	\$0.11		
JM8024	Lift Assembly to put Cylinder on rear Welding required	\$63.06	 <p>\$37.00 Price \$12.00 \$14.00</p>	
JM8027	R Sections S20-4639 Fine Serrated - Tiger Jaw Pack of 10	\$19.75 per pack		
JM8028	R+ Sections S20-4317 Coarse Serrated - Tiger Jaw Pack of 10	\$19.75 per pack		
JM8029	S20-4268 B+ Single Blade Knife Section - Pack of 10	\$19.75 per pack		
JM8042	SCH Sections	\$1.97 each		
JM8030	They come in a box of 25 For 7 ft., order 30 pc. For 9 ft., order 40 pc.	\$41.25 per box of 25		
JM8031	S35-2289 7 Ft. BT Single Blade Knife Complete	\$162.00		
JM8032	S35-2362 7 ft. Course BT Tiger Jaw Knife Complete	\$175.00		
JM8033	SCH Knife - 7 ft. Complete	\$180.00		
JM8034	9 ft. Knife Complete Single or Tiger Jaw, Coarse or Fine or SCH	\$196.91		
JM80754	Cotter Pin NEW! 3/16 x 2	\$0.60		
JM84389548	DS Hold Down (7 for 7' Bar, 9 for 9' Bar)	\$8.15	<i>Top of the line wear-resistant!</i>	
JM850137	Long Outer Hold Down Use on far end of bar	\$10.32		
JM858740	Knife Head, Single Blade with Bushing	\$72.50		

PRICES SUBJECT TO CHANGE WITHOUT NOTICE

PART NUMBER	DESCRIPTION	PRICE		
JM86503333	Spline Yoke On PTO before housing Use JM200-1200 cross & bearing kit.	\$168.30		
JM86527961	Inner Wear Shoe	\$78.00		
JM866617759	LH Section NEW!	\$6.07		
JM866617760	RH Section NEW!	\$6.07		
JM86622662	Hold Down Shim Please specify thickness: .03" thick .06" thick .10" thick .12" thick	\$1.04		
JM87013818	F-Bracket Roll Pin	\$1.34		
JM87422066	C Sections Tiger Shark NEW! (Extra large serrated)	\$1.98		
JM87517382	High Inner Hold Down Use on bar end closest to head	\$9.50	<i>Top of the line wear-resistant!</i>	
JM9617871	Mower Quadrant	\$171.53		
JM9809671	Tractor Yoke Pin	\$16.00		

PRICES SUBJECT TO CHANGE WITHOUT NOTICE

717.464.1043

NH 450, 455 >> AFTERMARKET REPLACEMENT MOWER PARTS

New Holland® is a Registered Trademark of CNH Industrial America LLC which does not manufacture or endorse these parts.

*Did you know there is a difference between the knife heads on your mower?
If you don't have the right knife head, your blades will not go over center on the center of the guard, but rather a 3/4" away from the guard. The results are that it is NOT cutting properly. ALWAYS check when you put new blades on your knife!*

PART NUMBER	DESCRIPTION	PRICE	
JM13818	455 Head Needle Bearing (3 piece per mower)	\$18.30 each	
JM143600	455 Head Plate	\$15.89 each	
JM32431	455 Dust Shield – 3/8 Hole	\$4.92	
JM63778	455 Dust Shield – 7/8" Hole	\$4.00	
JM63782	Short Bearing Spacer	\$33.54	
JM63797	455 Dust Shield – 5/8 Hole	\$4.48	
JM63798	Crankshaft With 455 pin but has 8 splines <i>Always count your splines!</i>	\$326.00	
JM63802	450-455 Connector Rod Bearings included	\$105.60	
JM63805	455 Head Needle Bearing (6 piece per mower)	\$8.70	
JM63806	455 Crank Pin	\$33.89	
JM63839	Long Bearing Spacer	\$38.70	
JM63841	Old Style 455 Knife Head Bushing w/ Taper	\$73.94	
JM8035	Triple Guard	\$46.44	

We carry used parts of most 455 & 450 head parts not listed

PRICES SUBJECT TO CHANGE WITHOUT NOTICE

JOE'S MACHINERY LLC

NH 402 >> AFTERMARKET REPLACEMENT CRIMPER PARTS

New Holland® is a Registered Trademark of CNH Industrial America LLC which does not manufacture or endorse these parts.

PART NUMBER	DESCRIPTION	PRICE	
JM8036	402 Gear Box Bearings – Seals (Timken) 4 pc. 67048 Brg, 4 pc. 67010 Race, 2 pc. JM181991A Oil Seal	\$80.96	[PHOTO NOT AVAILABLE]
JM8037	All Parts With Cylinder and 1 Hose to Put Hydraulics on Crimper	\$390.00	
JM8038	JM402 Wheel Bearing Kit	\$12.27	
JM163641	Top 402 Roll Brg. Comes with collar	\$26.50	
JM184347	60x15 Idler Sprocket (1/2" bore) 2 piece per crimper	\$42.90	
JM189785	Bearing Dust Shield Bottom	\$15.02	
JM28280	Bushing for Crimper PTO NEW!	\$60.41	
JM29840	PTO Dog Spring	\$6.68	
JM29860	PTO Dog Pin	\$6.70	
JM33943	Lift Crank Bearing NEW! (Used)	\$20.00	
JM3818	Bottom Roll Bearing - Sealmaster NEW! For NI Crimper	\$172.55	
JM3834	Top Roll Bearing - Sealmaster NEW! For NI Crimper	\$287.10	

PRICES SUBJECT TO CHANGE WITHOUT NOTICE

717.464.1043

NH 402 » AFTERMARKET REPLACEMENT CRIMPER PARTS

PART NUMBER	DESCRIPTION	PRICE		
JM46520	Shear Pin (per pack of 10)	\$6.10		
JM47216	Bearing on PTO NEW! 600 RST	\$11.50		
JM56482	Roll Adjustment Block (threaded)	\$23.04		
JM63586	402 Crimper Shaft (Gear box to shear pin hub)	\$130.07		
JM65790	Drive Hub with Shear Pin Hole	\$63.72		
JM65792	85 Pitch #60 USA Chain to Drive Rolls	\$88.19		
JM65812	402 Crimper Rolls	\$770.00 each		
JM65931	Top Drive Sprocket with Shear Pin Hole	\$64.75		
JM66480	Top and Bottom Roll Sprocket 60x24 Tooth with Special Hub	\$92.92		
JM80120	Side Wheel Only NEW!	\$157.03		
JM80121	Hub Only For Side Wheel Kit NEW!	\$47.27		
JM80122	Spindle Only For Side Wheel Kit NEW!	\$35.99		

PRICES SUBJECT TO CHANGE WITHOUT NOTICE



PART NUMBER	DESCRIPTION	PRICE	
JM80123	Teeth Only NEW! For Side Wheel	\$2.34	
JM80124	Top Crimper Roll Bearing Holder NEW! With threaded holes Not Original	\$23.13	
JM86575514	Bottom 402 Roll Brg. Comes with collar	\$84.00	
	Also fits 401 Crimper Roll Top and Bottom		
JM86620027	Bearing Flange (bottom) 4 piece	\$6.91	
JM86633054	Bearing Dust Shield (top) 2 pieces (Old number was 216912)	\$42.14	
JM86635012	Bearing Flange (top) 4 piece (Old number was 48222)	\$42.14	
JM52212	PTO Dog Yoke on 402 <i>Limited Supply</i>	\$140.00	
JM8039	Side Wheel Kit for NH, NI Crimpers <i>To Use Your Original 7' Crimper And Make it a 9!</i>	\$466.72	
JM8040	We have lots of used lift cranks in stock!	\$35.00	

PRICES SUBJECT TO CHANGE WITHOUT NOTICE



717.464.1043

NH >> AFTERMARKET REPLACEMENT HAYBINE® PARTS

New Holland® and Haybine® are Registered Trademarks of CNH Industrial America LLC which does not manufacture or endorse these parts.

HAYBINE® SKID SHOES			
PART NUMBER	DESCRIPTION	PRICE	
JM137129	467 Skid Shoe (2 pieces required)	\$88.23 a piece	
JM177000	495 Skid Shoe - LH (1 piece required)	\$144.01	
JM196102	469 Skid Shoe (2 pieces required per haybine)	\$82.50 a piece	
JM252371	495 Skid Shoe - RH (1 piece required)	\$158.00	
JM216426	479 Shoe (2 pieces required per haybine)	\$96.66 a piece	
JM216426	488 Shoe (2 pieces required)	\$96.66 a piece	
JM216447	479 Guard (1 piece required)	\$88.80	
JM216447	488 Guard (1 piece required)	\$88.80	
JM216933	472 Shoe (1 piece required)	\$85.19 a piece	
JM216933	477 Shoe (2 pieces required)	\$85.19 a piece	
JM216933	478 Shoe (2 pieces required)	\$85.19 a piece	

PRICES SUBJECT TO CHANGE WITHOUT NOTICE

HAYBINE® SKID SHOES			
PART NUMBER	DESCRIPTION	PRICE	
JM216966	472 Guard (1 piece required)	\$88.80 a piece	
JM216966	477 Shield (1 piece required)	\$88.80 a piece	
JM216966	478 Guard (1 piece required)	\$88.80 a piece	
JM634783	474 Shoe (2 pieces required per haybine)	\$97.10 a piece	
JM634783	489 Small Shoe (2 pieces required per haybine)	\$97.10 a piece	
JM634783	492 1465 499 Small Shoe (2 pieces required per haybine)	\$97.10 a piece	
JM626183	Pin to fasten shoe	\$13.54	[PHOTO NOT AVAILABLE]
JM770942	474 Shield (1 piece required)	\$96.05	
JM770942	489 Large Shoe (1 piece required)	\$96.05	
JM770942	492 1465 Large Shoe (1 piece required)	\$96.05	

HAYBINE® KNIVES			
PART NUMBER	DESCRIPTION	PRICE	
JM134186	Under Serrated 9 ft. Bolted Knife for 461-460	\$266.57	
JMFQ215	Haybine Guard	\$16.00	
JM648844	Under Serrated 9 ft. Bolted Knife for 469	\$274.73	
JM76517	Reel Tine for All Haybines (Except for 495 Haybines)	\$3.48	
JM8029	JMS20-4268 B+ Single Blade Knife Section	\$19.75 pk of 10	
JM8042	SCH Sections (work well in grass or alfalfa)	\$1.97	
JM8030	25 in a box SCH Sections	\$41.25	

PRICES SUBJECT TO CHANGE WITHOUT NOTICE

717.464.1043

HAYBINE® KNIVES			
PART NUMBER	DESCRIPTION	PRICE	
JM86616989	Bolted Under Serrated (7 ft.) for 474	\$284.06	
JM86616990	Bolted Top Serrated (7 ft.) for 474	\$253.07	
JM86617059	RH Guard	\$48.73	 
JM86617060	LH Guard	\$54.17	
JM86617061	Stub Guards FQ250	\$16.50	
JM86624469	Bolted Under Serrated (9 ft.) for 489-492-1465	\$298.70	
JM86837281	Under Serrated (7 ft.) Bolted for 467	\$246.60	
JM9623570	Bolted Under Serrated (9 ft.) for 479-488	\$246.60	
JM9623571	Bolted Under Serrated (7 ft.) for 472-477-478	\$250.82	
JM9623572	Bolted Under Serrated (12 ft.) for 495	\$311.08	[PHOTO NOT AVAILABLE]





HAYBINE® KNIFE HEADS AND BUSHINGS			
PART NUMBER	DESCRIPTION	PRICE	
JM46826	Bushing	\$88.04	
JM577867	Knife Head for 479-488	\$123.75	
JM612408	Knife Head Bushing for 474-489-492-1465	\$68.08	
JM80289488	Knife Head for 474-489-492-1465	\$123.75	
JM80577868	Knife Head for 472-477-478	\$123.97	
JM86507377	Knife Head for 460-461-467-469	\$124.56	

PRICES SUBJECT TO CHANGE WITHOUT NOTICE

HAYBINE® KNIFE HEADS AND BUSHINGS

PART NUMBER	DESCRIPTION	PRICE	
JM86508155	Knife Head for 495	\$135.90	
JM87297020	Knife Head Bushing with Bolt for 472-477-478-479-488-495	\$45.10	
JM254132	Knife Head Bushing without Bolt	\$30.10	
JM87297021	Knife Head Bushing with Bolt for 461-467-469	\$38.78	
JM134182	Knife Head Bushing without Bolt	\$23.78	

HAYBINE® PARTS

PART NUMBER	DESCRIPTION	PRICE	
JM121831	Screw Cap on Cam Bearing NEW!	\$10.24	
JM127637	Bushing 469 Wobble Box NEW!	\$69.01	
JM127820	LH Tine	\$10.56	
JM129295	Gib Key NEW!	\$13.37	
JM134142	Triangle Plate with Shaft On 472, 477, 478, 479, 488	\$83.10	
JM144463	Sprocket For Roll Drive	\$81.06	
JM144466	Lower Roll Drive Chain #60 90 Pitches	\$91.08	
JM144523	Sprocket	\$92.67	

PRICES SUBJECT TO CHANGE WITHOUT NOTICE

HAYBINE® PARTS			
PART NUMBER	DESCRIPTION	PRICE	
JM163641	Ball Bearing for Rolls Comes with locking collar 472 - 4 pc. / 474 - 4 pc. / 477 4 pc. / 478 4 pc. / 467 - 4 pc.	\$26.50 Each	
JM165484	Cam Bearing on Tine Bar End	\$22.27	
JM174633	Skid Shoe Clips Fits 469-472-477-478-479-488-495	\$12.00	
JM189785	Bearing Dust Shield for: 479 - 2 pc. / 461 - 4 pc. / 469 - 4 pc. / 460 - 4 pc. / 495 - 2 pc.	\$15.02 Each	
JM204326	Output Angle Gearbox Shaft for 472, 477, 478 205/8" shaft	\$205.00	
JM215855	Linkweld Assembly for: 472 - 2 pc. / 477 - 2 pc. / 478 - 2 pc.	\$115.03 Each	
JM216294	Tine Bar 8¾" fits 477	\$104.93	
JM216497	Output Angle Gearbox Shaft for 479, 488 23.75" shaft	\$168.00	
JM226870	Linkweld Assembly for: 479 - 2 pc. / 488 - 2 pc. / 469 - 2 pc. / 495 - 2 pc.	\$115.03 Each	
JM247911	Tine Bar 6¾" fits 477	\$104.93	
JM252653	Cam Track (used) for 469, 472, 477, 478, 479, 488,	Call for Price	[PHOTO NOT AVAILABLE]
JM255649	Input Angle Gearbox Shaft for 472, 478, 479, 488	\$134.00	
JM261958	RH Wear Plate At outer edge of knife	\$21.84	
JM263736	Tine Bar 8.5"	\$104.86	
JM263738	Tine Bar 7⅝" <i>All 488-489-492-1465 use 2 different style tine bars. Always measure from end of tine bar to second hole.</i>		

PRICES SUBJECT TO CHANGE WITHOUT NOTICE









HAYBINE® PARTS			
PART NUMBER	DESCRIPTION	PRICE	
JM264871	Clip-on Tine Bar	\$7.12	
JM280369	Knife Bolt & Nut 5/8 x 3 1/2 FT.Gr.8 474, 489, 492, 1465 NEW!	\$3.22	
JM283594	16 Tooth Sprocket 489 Wobble Box NEW!	\$67.70	
JM285667	Bushing Drive Line NEW!	\$21.68	
JM285879	488-479 Hub Sprocket Weld Assy. NEW!	\$160.95	
JM285969	Hub Sprocket Weld Assembly 478, 477, 472	\$194.47	
JM286078	Reel Bushing	\$13.93	
JM289416	Bearing Guide NEW!	\$2.82	
JM570384	Reel Belt Tension Spring Subs to JM87579261	\$29.49	
JM573376	Yoke and Pin 488 NEW! BSN 587749	\$28.85	
JM575246	Tine Bar Bearing Housing Subs to 86631094	\$62.36	

PRICES SUBJECT TO CHANGE WITHOUT NOTICE

HAYBINE® PARTS

PART NUMBER	DESCRIPTION	PRICE	
JM579497	Clip 474, 489, 492, 1465 NEW!	\$0.81	
JM58106	Reel Belt Idler Pulley for 482, 488, 489, 1465 Subs to 86631120	\$82.46	
JM612377	Rear Baffle on 474, 489, 492	\$98.00	
JM614671	Bushing on Knife Arm NEW! .999 O.D.	\$63.81	
JM647876	Wear Strip NEW!	\$7.50	
JM689165	Wobble Shaft on 474, 489, 492, 1465	\$490.00	
JM700035	1¼x6 Spline Yoke on Rear of Front PTO for 489	\$95.90	
JM701562	Bushing on Knife Arm NEW! fits 489, .874 O.D.	\$74.37	
JM705116	Tine Bar 8⅝" fits 472-478	\$117.63	
JM705117	Tine Bar 7⅝" fits 472-478	\$117.63	
JM709063	Bushing NEW! fits 489, .874 O.D.	\$53.61	
JM763026	Washer NEW! for 489 Yoke	\$22.80	

PRICES SUBJECT TO CHANGE WITHOUT NOTICE

HAYBINE® PARTS			
PART NUMBER	DESCRIPTION	PRICE	
JM763883	Haybine PTO Set Screw for Yoke #70035 NEW!	\$8.75	
JM764347	Yoke on 474, 489, 492, 1465	\$462.50	
JM764892	Knife Head Arm For 489, 492, 1465	\$574.86	
JM76516	RH Tine	\$12.66	
JM772028	Tine Clip (Used) NEW!	\$3.00	
JM782590	Cam Track (Used) 474, 489, 492	Prices vary depending on condition and availability. Call for info	
JM80201	Guard Bolts & Nuts for 7' NEW!	\$17.08 per kit	
JM80202	Guard Bolts & Nuts for 9' NEW!	\$20.75 per kit	
JM8043	Haybine PTO for 479-478-489-492	\$747.45	
JM8044	NH489, 492 Hydraulic Tongue Swing Kit with cylinder and hoses	\$528.07	

PRICES SUBJECT TO CHANGE WITHOUT NOTICE

717.464.1043

HAYBINE® PARTS			
PART NUMBER	DESCRIPTION	PRICE	
JM8045	NH489, 492, 1465 Haybine Rolls <i>Original style - You can change only 1 roll, then divide the price by half.</i>	\$4,030.00 per set of 2	
JM80579116	Pin Drive 489 NEW!	\$2.78	
JM850136	Hold Down RD Sub Guard NEW!	\$92.99	
JM86528220	Tube Weld Assembly	\$82.35	
JM86575514	Ball Bearing for Rolls Comes with locking collar for: 479 - 4 pc. / 488 - 4 pc. / 461 - 4 pc. / 460 - 4 pc. / 469 - 4pc. / 489 - 4 pc. / 492 - 4 pc. / 495 - 4 pc. / 1465 - 4 pc. (High quality brg.)	\$84.00 Each	
JM86620027	Roll Bearing Flange for: 479 - 4 pc. / 488 - 4 pc. / 460 - 4 pc. / 489 - 4 pc. / 492 - 4 pc. / 495 - 4 pc.	\$6.91 Each	
	461 - 4 pc. / 467 - 4 pc. / 1465 - 4 pc.	\$6.91 Each	
JM86625582	RH Divider Assembly	\$60.33	
JM86627870	Idler Sprocket - Specify what size	\$41.25	

PRICES SUBJECT TO CHANGE WITHOUT NOTICE

HAYBINE® PARTS			
PART NUMBER	DESCRIPTION	PRICE	
JM86629289	Skid Shoe Clips Fits 474-489-492-1465	\$20.04	
JM86631017	Low Stub-Guard Hold Down	\$16.40	
JM86631018	High Stub-Guard Hold Down	\$36.55	
JM86631102	Reel Belt Idler Pulley for 482, 488, 489, 1465	\$111.88	
JM86633047	Shroud (Dust shield) for: 479 - 2 pc.	\$25.82 Each	
JM86633054	Bearing Dust Shield for 477 - 4 pc.	\$42.14 Each	
JM86635012	Bearing Flange for: 472 - 8 pc. / 474 - 8pc. / 467 - 8 pc. / 477 - 8pc. / 478 - 8pc.	\$42.14 Each	
JM87449	Nut for 489 Yoke NEW! Inside wobble box	\$1.78	

JM87500 – All New Bearings, Races and Seals on 489 Wobble Box

Price **\$350.00**

Call for any haybine wobble parts or send yours in for repair!

PRICES SUBJECT TO CHANGE WITHOUT NOTICE

717.464.1043

HAYBINE WOBBLE BOX BEARINGS, RACES, OIL SEALS

For Prices go to Bearings Pages

472, 477, 479, 488, 495 HAYBINE WOBBLE BOX

Aftermarket	New Holland	Qty.	Description
JML68111 or L68110	175508	2	
JMJLM104910	199955	2	Race
OR			
JMJLM104911	287066	2	Race
JMRA100RR	134130	1	Bearing
JMJLM104948	199954	2	Bearing
JML68149 Brg.	175507	2	Bearing
JM24904	223297	1	Seal
JMLM11900LA	67372	2	Bearing
JMLM11910	36725	2	Race

For reference number 2 and 3 check the aftermarket number on the old race. The outside diameter is not always the same

474, 489, 492 HAYBINE WOBBLE BOX

Aftermarket	New Holland	Qty.	Description
JM15112	29139	1	Bearing
JM15245	289966	2	Race
JM471652	288875	1	Seal
JMJLM710910	221003	2	Race
JMJLM710949C	221002	2	Bearing
JM15123	29140	1	Bearing
JM471413	712341	1	Seal
JMB2812	706065	2	Needle Bearing
JM473237	225615	1	Seal

461, 467, 469 HAYBINE WOBBLE BOX

Aftermarket	New Holland	Qty.	Description
JMRA100RR	134130	1	Ball Bearing
JMLM6033011	67526	1	Race
JMLM67010	36723	2	Race
JMLM11900LA	67372	2	Bearing
JMLM11910	36725	2	Race
JMLM603049	67527	1	Bearing
JMLM67048	36726	2	Bearing
JMJLM104911	287066	1	Race
JMLM104949	287902	1	Bearing



PRICES SUBJECT TO CHANGE WITHOUT NOTICE

REPLACEMENT HAYBINE® BELT CHART

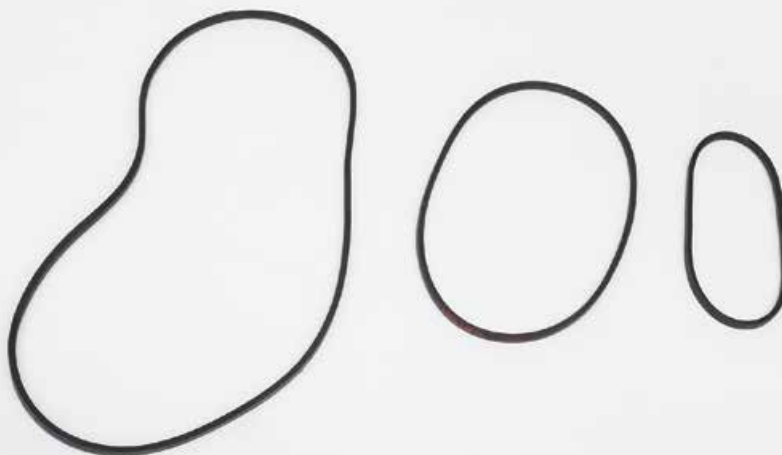

Model Numbers	Part #	Sub's to Part #	Belt Size	Price
467 Gearbox	JM137203	---	2/B55	\$55.98
461 Gearbox	JM165419	---	C81	\$50.99
469-479-488 Gearbox	JM214252	80046914	C83	\$51.68
472-477-478 Gearbox	JM225915	---	C79	\$49.67
495 Reel	JM242999	66232	C122	\$75.90
495 Gearbox	JM227247	---	C78	\$48.84
474-489-492 Gearbox	JM284062	86627789	C57	\$35.85
474-489-492 Reel	JM284063	86633896	C90	\$56.55
460 Gearbox	JM577900	---	C74	\$51.80
467-469-472-477-478-479-488 Reel	JM63106	873115599	C128	\$79.60
460-461 Reel	JM86627790	86633896	C90	\$56.55

PRICES SUBJECT TO CHANGE WITHOUT NOTICE

717.464.1043

NH 56, 256, 258, 260 >> AFTERMARKET REPLACEMENT RAKE PARTS

New Holland® is a Registered Trademark of CNH Industrial America LLC which does not manufacture or endorse these parts.

PART NUMBER	DESCRIPTION	PRICE		
JM134262	Hitch and Jack Assembly	\$275.30		 <i>Fits all NH Rakes</i>
JM136638	Cast Assembly (for Rake Dolly) NEW!	\$90.00		
JM136639	Tongue for Rake Dolly NEW!	\$73.28		
JM136642	Axle for Rake Dolly NEW!	\$137.05		
JM139019	258 Star	\$281.36		
JM139125	Lift Bearing Assembly Fits 256, 258, 259, and 260 only	\$71.69		
JM139125A	Lift Bearing Assembly Fits 55 and 56 only	\$69.38	 JM139125B	 JM139125A
JM139125B	Lift Bearing Assembly Bushing TS114PT162 Bushing	\$6.50		
JM139138	258 Ball Pivot	\$31.32		
JM139141	Connector Plate At JM139138	\$28.66		
JM139153	Clutch Cable	\$12.21		
JM143024	258 Bar Dust Cap	\$2.94		

PRICES SUBJECT TO CHANGE WITHOUT NOTICE

NH 56, 256, 258, 260 » AFTERMARKET REPLACEMENT RAKE PARTS

PART NUMBER	DESCRIPTION	PRICE		
JM172856A	Aftermarket Replacement Seal Goes in 258 bar ends package.	\$7.99		
JM181991	Hydraulic Motor Star Seal	\$8.16		
JM182196	Dust Guard Fits on JM48149	\$6.20	Above serial # on 256 - 188146 on 258 - 188892	
JM187065	Arm Lift	\$65.60		
JM204041	Lift Spring	\$26.87		
JM258	Bar End Complete Package Fits 258,259,260	\$44.25	JM258	JM258S 
JM258S	Sealed Bar End Bearing Package	\$46.50		
JM280744	Short Neck Carriage Bolt NEW! For on steel teeth	\$1.74		
JM32383	Wheel Lug Bolt NEW!	\$1.30		
JM33781	Crank Knob	\$14.65		
JM33914	Clutch Cable Lever (On Front)	\$22.29		
JM48138	Tine Bar Bearing Comes with dust shield. Fits all 56, 256 rakes	\$27.00		
JM48138A	Bolt Only	\$7.30		
JM48149	Star Hub with Dust Shield	\$96.50		

PRICES SUBJECT TO CHANGE WITHOUT NOTICE

717.464.1043

NH 56, 256, 258, 260 >> AFTERMARKET REPLACEMENT RAKE PARTS

PART NUMBER	DESCRIPTION	PRICE		
JM48155	256 Star	\$290.29		
JM48219	256 Star Support	\$7.38		
JM48315	LH Rake Crank - Long	\$116.55		
JM48316	RH Rake Crank - Short	\$107.30		
JM48329	Link Block Lift	\$58.77		
JM34025	Link Block Bushing Only	\$9.40	 JM34025	
JM616780	Snap Ring 256 Bar End NEW!	\$0.73		
JM63086	Ring Closure NEW!	\$15.28		
JM641627	258 Bar Pin	\$7.89		
JM64562	Steel Rake Tooth	\$2.33		
JM646694	258 Rake Bar	\$260.00		
JM67015	RH Star Spindle on Model 56 Only	\$82.93		
JM704386	Crank Nut without Thread	\$31.96		
JM707750	Crank Nut with Thread	\$59.80		
JM718013	Bar Bearing Bushing	\$3.64		
JM792493	Steel Rake Tooth Clip	\$0.98		

PRICES SUBJECT TO CHANGE WITHOUT NOTICE

NH 56, 256, 258, 260 » AFTERMARKET REPLACEMENT RAKE PARTS

PART NUMBER	DESCRIPTION	PRICE		
JM8046	56B Bar Thick as 258, but fits only 56B Rakes	\$182.13		
JM8047	6 x 22 Diamond Plate Wheels - 4 Lug Hub Center We use smaller diameter wheels for better raking performance!	\$166.75 Each		
JM8049	Complete Hydraulic Drive Kit with Motor and Hoses to Tractor	\$725.00		
<p><i>Specify length of hoses either for tractor or engine hookup. Hoses are 3 ft longer for a dolly wheel rake. Always specify!</i></p>				
JM8050	Hydraulic Hoses and Fittings	\$271.04		
JM8051	Hydraulic Motor	\$241.60		
JM8052	Hydraulic Motor Bracket	\$65.31		
JM8053	Hydraulic Motor Coupler	\$72.55		
JM8054	Hydraulic Motor Star Bearings – 67048 China	\$3.86		
JM8055	Hydraulic Motor Star Race – 67010 China	\$3.47		
JM8056	Hydraulic Motor Star Bracket	\$168.98		
JM8057	Hydraulic Motor Star Shaft	\$107.44		
JM8057A	Engine Mount Brackets	\$120.42		
JM8058	Hydraulic Unit with Honda Engine to Mount on Rake 8HP or 13 HP	Call for Price	[PHOTO NOT AVAILABLE]	
JM8059	258 Bar End Only to weld to your old bar	\$37.46		
JM8060	256 Bar End Only to weld to your old bar	\$29.43		
JM8061	NH Rake Dolly complete with wheels	\$807.64		
JM8061A	Complete Front Dolly Wheel	\$192.00		
JM8062	NH Rake Dolly without wheels	\$393.64		

PRICES SUBJECT TO CHANGE WITHOUT NOTICE

717.464.1043

NH 56, 256, 258, 260 » AFTERMARKET REPLACEMENT RAKE PARTS

REFERENCE	PART NUMBER	QTY	DESCRIPTION	PRICE
1	JM48253	1	FRONT AXLE	\$53.65
2	JM289671	3	3/8 x 2 1/2 GR8 Bolt, Nut, Lockwasher	\$1.67
3	JM139050	1	RH UNIVERSAL – (Uses 675 Series C&B Kit)	\$90.75
5	JM139842	2	675 CROSS & BEARING KIT	\$18.03
	JM80711	2	LUBE NIPPLE – 65 Degree, 1/8" NPT x 7/8" lg	\$0.83
6	JM139112	1	SPINDLE – RH (LH on Model 260), Complete	\$120.25
6a	JM10	1	COTTER PIN	\$0.60
7	JM86837915	2	SLOTTED NUT	\$12.69
8	JM46876	4	OIL SEAL – Oil	\$7.25
9	JM36726C	4	BEARING CONE – LM67048 China Bearing	\$3.60
10	JM36723C	4	BEARING CUP – LM67010 China Race	\$3.47
11	JM143467	1	BEARING HOUSING – RH	\$128.58
11a	JM87974	3	BOLT – Hex 1/2" x 3 GR5 HH Bolt, Lockwasher, nut	\$1.70
12	JM143469	1	BEARING HOUSING – LH	\$126.27
	JM87414	2	LUBE NIPPLE – 1/4" - NPT	\$0.89
13	JM48281	1	DOG – RH (LH on Model 260)	\$3.84
14	JM48283	2	CLEVIS PIN	\$1.28
15	JM35949	1	SPRING – Dog, RH (LH on Model 260)	\$2.19
16	JM179492	2	HUB – Wheel, Includes (2) ref. 17	\$98.53
	JM87414	2	LUBE NIPPLE – 1/4" - 28 NPT	\$0.89
17	JM257702	4	1 1/2 BUSHING – Always ask customer for OD measurement, it is either 1 3/8 or 1 1/2	\$9.25
17a	JM65930	4	1 3/8 BUSHING – Always ask customer for OD measurement, it is either 1 3/8 or 1 1/2	\$9.25
18	JM64972	1	1 1/4 SMALL RIM MACHINERY WASHER	\$2.10
19	JM139052	1	LH UNIVERSAL – Complete with 1 pc. 3/8 x 2 1/2 GR8 Bolt, Flange Nut (Uses 675 Series C&B Kit)	\$90.75
19a	JM80768	1	WOODRUFF KEY – #15, 1/4" x 1"	\$1.28
21	JM139116	1	SPINDLE – LH (RH on Model 260)	\$123.95
23	JM48282	1	LUG – Dog, LH (RH on Model 260)	\$3.84
24	JM35948	1	SPRING – Dog, LH (RH on Model 260)	\$2.76
25	JM34030	1	HARDENED PIN – It's harder than GR8 Bolts!	\$7.49
26	JM139349	1	UNIVERSAL – Use 1pc. 5/16 x 2 1/2 GR8 Bolt, Flange Nut (Uses 12 Series C&B Kit)	\$131.38
30	JM39360	1	BEARING ASSEMBLY – 12 Series Cross and Bearing Kit	\$17.37
31	JM8047	2	6x22 Diamond Plate Wheel	\$166.75
31A	JM32383	8	BOLT – Hex 1/2" – 20x1 3/16 GR 5 - Wheel Lug Bolt	\$1.30
32	JM8065	2	RAKE WHEEL COMPLETE – 5.0 x 15L	\$195.75
33	JM256-258	1	RH Dog, Spring, Pin Kit	\$7.70
34	JM256-258	1	LH Dog, Spring, Pin Kit	\$7.70

NOTE

When jacking rake up so wheel spins freely, it should always make a “click, click” sound when you spin it in reverse. If it doesn’t, then take the wheel and hub off, and clean all old grease out of the hub. Then check for worn out dog, dog spring, etc.

PRICES SUBJECT TO CHANGE WITHOUT NOTICE

JOE'S MACHINERY LLC



PRICES SUBJECT TO CHANGE WITHOUT NOTICE

717.464.1043

NH 56, 256, 258, 260 » AFTERMARKET REPLACEMENT RAKE PARTS

REFERENCE	PART NUMBER	QTY	DESCRIPTION	PRICE
1	JM139843	1	GEARBOX – 256, 258, 259, includes Ref. 2-24	\$1,440.00
2	JM48185	1	SPINDLE – Shaft & Pinion	\$111.74
2a	JM87053	1	WOODRUFF KEY – #127, ¼" x 2⅛"	\$3.70
3	JM143096	1	GEARBOX – Housing, 256, 258, 259	\$331.15
4	JM181991	2	OIL SEAL	\$8.16
5	JM36726C	3	BEARING CONE – LM67048 China Bearing	\$3.60
6	JM36723C	3	BEARING CUP – LM67010 China Race	\$3.47
7	JM9842737	1	YOKE – & Shaft	\$129.68
8	JM39360	1	12 SERIES CROSS BEARING KIT	\$17.37
8a	JM80711	1	LUBE NIPPLE – 65 Degree, ⅛" NPT x ⅞" lg	\$0.83
9	JM677847	1	TELESCOPING SHAFT	\$193.50
9a	JM88775	1	LUBE NIPPLE – ¼" – 28	\$1.00
10	JM139034	1	BEVEL PINION – Gear	\$111.50
11	JM139047	1	COLLAR – Clutch	\$124.30
12	JM48176	1	SPRING – Clutch	\$7.97
13	JM48174	1	BRACKET – Stop	\$63.05
14	JM36724C	1	BEARING CONE – LM11949 China Bearing	\$3.30
15	JM36725C	1	BEARING CUP – LM11910 China Race	\$2.05
16	JM87381	1	WASHER – 0.81"ID x 1.47" OD x 0.13" Thk.	\$0.47
17	JM116311	1	SLOTTED NUT – ¾" x 16	\$3.40
18	JM87395	1	COTTER PIN – ⅛" OD x 1¼" long	\$0.28
19	JM48191	1	DUST CAP	\$4.98
20	JM76031	1	CLUTCH INPUT SHAFT – Release, 256, 258, 259	\$16.47
20a	JM87872	1	BOLT – ⅝" - 18 x ¾", Gr 5	\$0.18
20b	JM9626568	1	JAM NUT – Jam, ⅝"-18	\$0.15
21	JM48173	1	YOKE – Clutch	\$132.14
21a	JM280112	2	BOLT – Hex, ¼" – 20 x 1½, Gr 5	\$0.18
21b	JM80682	6	LOCK WASHER – ¼"	\$0.17
21c	JM7770	2	NUT – Hex, ¼" – 20, Gr 5	\$0.15
22	JM86537848	1	GASKET SEALANT	\$14.60
23	JM48180	1	COVER	\$17.11
23a	JM88542	6	BOLT – Hex, ¼" – 20 x ½", Gr 5	\$0.15
23b	JM80682	6	LOCK WASHER – ¼"	\$0.17
24	JM80781	1	PLUG – ⅜" – 18 NPT	\$1.06
24a	JM8048	1	GEAR BOX – Bearing and Race, and Oil Seal Kit China	\$65.22
24b	JM8048T	1	GEAR BOX – Bearing and Race, and Oil Seal Kit Timken	\$112.45
26	JM86511191	1	WASHER – 0.81" ID x 2" OD x 0.15" Thk	\$0.85
27	JM88886	1	SLOTTED NUT – ¾" – 16	\$1.47
27a	JM87395	1	COTTER PIN – ⅛" OD x 1¼" Long	\$0.28

NOTES

Ref. #2 JM48185 sometimes needs shimming to properly match with ref. #10 JM139034.

We use China bearings and races in the gearbox. Specify if you want timken.

Ref. #23 cover only uses gasket sealant, not a gasket. For gasket sealant, order Ref. #22.

When rebuilding gearbox, use grease pump grease only, but pack it into the front at star before installing the last bearing and also into the back before putting the last cover on. Fill to almost full. Check level annually!

PRICES SUBJECT TO CHANGE WITHOUT NOTICE

JOE'S MACHINERY LLC

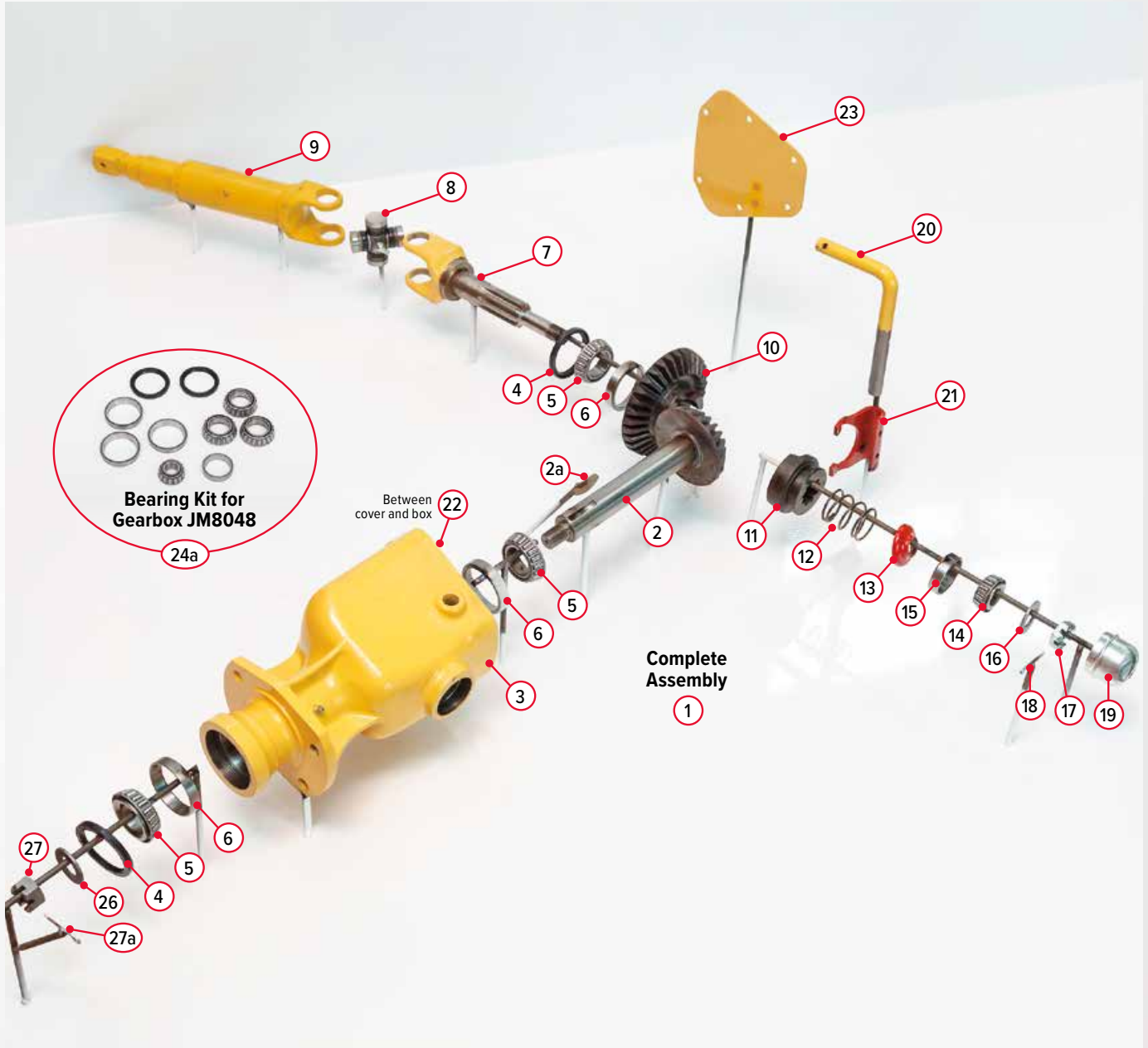

PRICES SUBJECT TO CHANGE WITHOUT NOTICE

717.464.1043

NH 56, 256, 258, 260 » AFTERMARKET REPLACEMENT RAKE PARTS

PART NUMBER	DESCRIPTION	PRICE		
JM8063	4 Bolt Rake Wheel Rim 5.00 x 15L	\$107.25 each		
JM8064	Rake Tread Tire 5.00 x 15L	\$99.00		
JM8065	Rake Wheel Complete 5.00 x 15L	\$195.75		
JM80793	Expansion Plug Goes on 258 bar ends.	\$2.89		
JM850612	256 Rubber Rake Tooth (1 Hole) Price Subject to Change	\$5.30	 56-256	 258 JM850613
JM850613	258 Rubber Rake Tooth (2 Holes) Price Subject to Change	\$5.30	JM850612	<i>High Quality Teeth</i>
JM850614	260 Rubber Rake Tooth (2 Holes)	\$5.30		
JM86837895	256 Bar Dust Cap <i>We now make our own!</i>	\$2.95		
JM86837915	Slotted Nut On Wheel Spindle	\$12.69		
JM86978339	Pivot Bracket	\$21.15		
JM87028576	256 Rake Bar	\$174.00		
JM9800135	260 Bar Pin NEW!	\$3.20		
JM9807906	260 Sealed Bar Bearing NEW!	\$18.90		

PRICES SUBJECT TO CHANGE WITHOUT NOTICE

NH 55 » AFTERMARKET REPLACEMENT RAKE PARTS

New Holland® is a Registered Trademark of CNH Industrial America LLC which does not manufacture or endorse these parts.

PART NUMBER	DESCRIPTION	PRICE	
JM139125A	Lift Bearing Assembly Fits 55 & 56 rakes.	\$69.38	
JM139138A	Complete Package To convert from ball socket outfit Will fit all 55 and 56 rakes. <i>The JM139141 plate does not fit the 55 Rake.</i>	\$89.00	
JM139349	Outer Universal Between wheel and gearbox.	\$131.38	
JM14463681	O-Ring NEW!	\$12.34	
JM181991	Oil Seal Fits on both gearbox ends	\$8.16	
JM204041	Lift Spring	\$26.87	
JM28966	Input Gearbox Bearing Race Takes 2 pieces	\$9.90	
JM33358	Output Shaft Snap Ring	\$38.15	
JM33469	Input Gearbox Bearing Takes 2 pieces	\$32.28	
JM33781	Crank Knob	\$14.65	
JM33829	55 Crank Nut with Threads	\$59.79	
JM33856	55 Inner Dog Hub	\$102.43	













PRICES SUBJECT TO CHANGE WITHOUT NOTICE

717.464.1043

NH 55 >> AFTERMARKET REPLACEMENT RAKE PARTS

PART NUMBER	DESCRIPTION	PRICE		
JM33915	Tine Bar Snap Ring NEW!	\$0.79		
JM33942	55 Rake Hub (6 Lug) Not available, but send yours in if broken in center, to have it redone. CALL!	\$126.50		[PHOTO NOT AVAILABLE]
JM33943	55 Crank Bearing	\$59.79		
JM33967	55 Rake Bar	\$174.00		
JM33967A	Bar End Only	\$42.90		
JM33968	Dust Shield on Bar	\$5.00		
JM33975	Star Hub Dust Shield on Gearbox	\$28.00		
JM33979	55 Dog Subs to 820921	\$48.05		
JM34019	C742 Dog Spring	\$3.19		
JM34032	Bearing Mounting BSN 34890 NEW! For Old Style 55 Rake Bars	\$84.12		
JM34033	Gearbox Input Shaft	\$25.68		
JM34039	Input Shaft Snap Ring	\$6.90		
JM34046	Clutch Yoke	\$19.50		
JM34040	Upper Gearbox Needle Bearing	\$26.10		
JM34041	Outer Gearbox Ball Bearing	\$20.88		

PRICES SUBJECT TO CHANGE WITHOUT NOTICE

PART NUMBER	DESCRIPTION	PRICE		
JM34048	Clutch Fork	\$46.98		
JM34057	Wheel Shaft 73" Long	\$109.15		
JM34058	Clutch Lever	\$21.91		
JM34065	55 Outside Reel RH Spindle	\$97.38		
JM34067	Gearbox Output Shaft	\$58.39		
JM34080	55 Star Hub	\$156.51		
JM36139	Lift Arm Weld Assembly	\$63.25		
JM39271	Ball NEW!	\$85.10		
JM39361	55 Gearbox Yoke	\$68.30		
JM46988	Axle Bushing in Bearing Housing	\$9.25		
JM46991	Right Axle Housing Bearing with Bushing	\$117.97		
JM46992	Left Axle Housing Bearing with Bushing	\$117.97		
JM48191	Hub Cap on Gearbox	\$4.98		

PRICES SUBJECT TO CHANGE WITHOUT NOTICE

NH 55 >> AFTERMARKET REPLACEMENT RAKE PARTS

PART NUMBER	DESCRIPTION	PRICE	
JM48329	Link Block Lift	\$58.77	
JM55	Bar End NEW!	\$28.62	
JM677847	Telescoping Shaft	\$193.50	
JM80765	1/4 x 1 1/8 Woodruff Key	\$2.55	
JM84913	1/4 x 1 1/2 Woodruff Key NEW!	\$2.35	
JM86523991	Rake Bar Bearing Kit on 55	\$39.17	
JM86637501	1/4 x 2 3/4 Woodruff Key NEW!	\$16.56	
JM86837316	Dog Pin	\$14.65	
JM86900802	Clutch Spring	\$12.60	

PRICES SUBJECT TO CHANGE WITHOUT NOTICE

NH 824 >> CORN HEAD - AFTERMARKET REPLACEMENT PARTS

Flexible Grease Lines With Quality Crimp Fittings

New Holland® is a Registered Trademark of CNH Industrial America LLC which does not manufacture or endorse these parts.

MAIN DRIVE GROUP View from Front

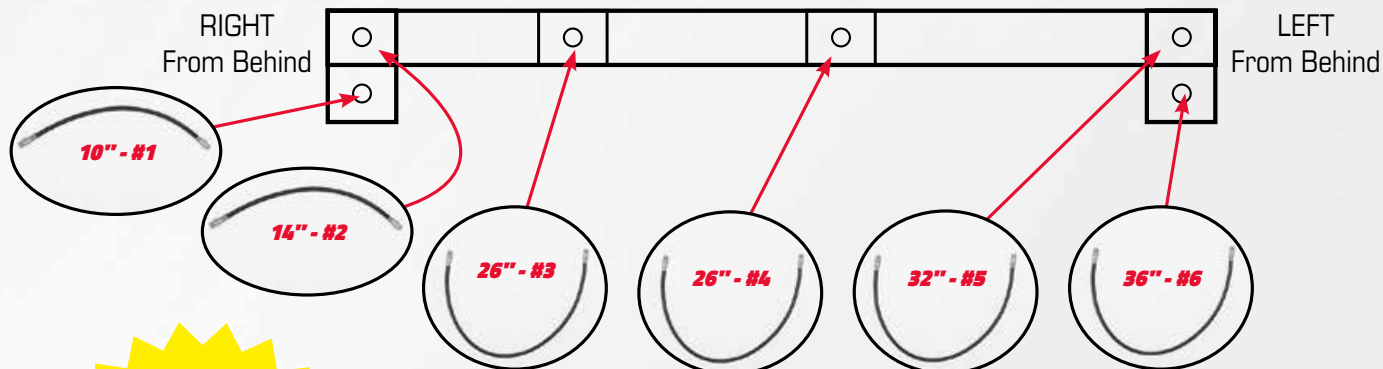

Customers are happy with these grease lines!
 Much easier to deal with!

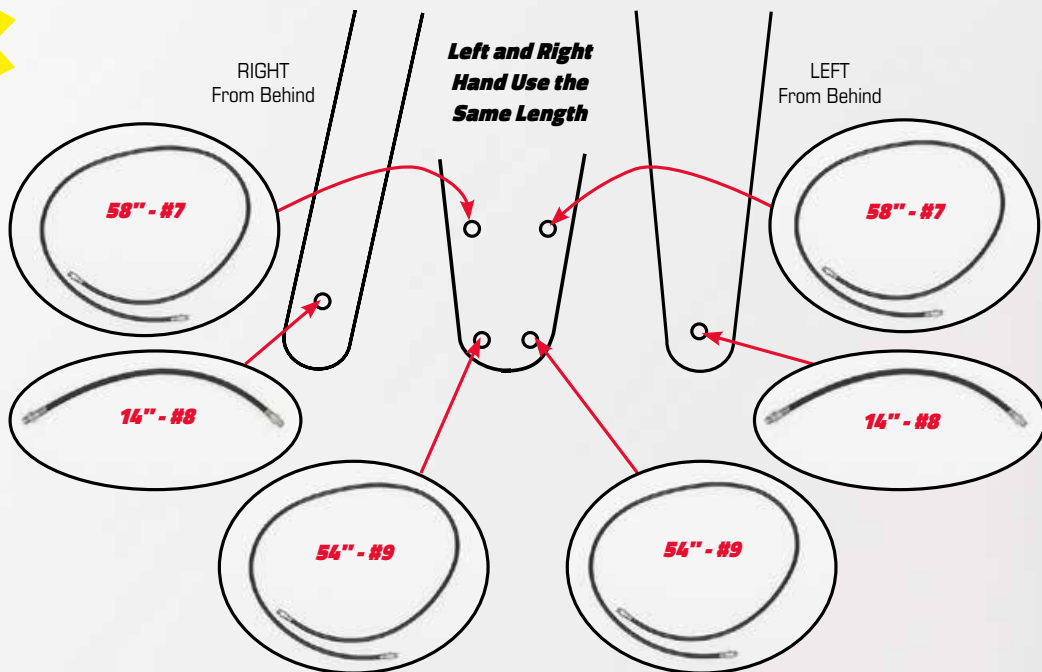

No more grease tube breaking in half!
Much easier to install!

Specify from 1 to 9 which number you need.

CORNHEAD GREASE LINES			
PART NUMBER	SIZE	PRICE	
JM80650	#1 10"	\$31.99	
JM80651	#2 14"	\$32.67	
JM80652	#3 26"	\$34.77	
JM80653	#4 26"	\$34.77	
JM80654	#5 32"	\$35.81	
JM80655	#6 36"	\$36.50	
JM80656	#7 58" x 2 pieces	\$37.37	
JM80657	#8 14" x 2 pieces	\$29.79	
JM80658	#9 54" x 2 pieces	\$39.62	
JM80660	Complete Set	\$420.00	

PRICES SUBJECT TO CHANGE WITHOUT NOTICE

717.464.1043

NH 824 >> AFTERMARKET REPLACEMENT CORN HEAD PARTS

PART NUMBER	DESCRIPTION	PRICE	
JM136740	Bearing & Shaft	\$58.48	
JM197297	Snap Ring NEW!	\$5.16	
JM20401708	Idler Sprocket 4017x1/2" Bore (on spinner drive chain, replaces NH#644208 wood block)	\$25.03	
JM230-240	824 Adaptor Kit To change your 824 cornhead to fit the FP230-240 choppers	\$1090.00	
JM25769	Washer 12mm NEW!	\$10.43	
JM280567	5/8 Slotted Nut NEW!	\$0.63	
JM285585	Cutting Disc Bolt NEW!	\$2.15	
JM44788	#40 USA Chain (44 pitches) For Cutting Disc Drive	\$23.07	
JM572735A	24 Tooth Sprocket NEW!	\$41.90	
JM573453	Cover	\$16.50	
JM574245	Hardened Washer NEW!	\$7.92	
JM619248	Bushing NEW!	\$38.15	
JM645115	Power Divider Universal	\$283.85	

PRICES SUBJECT TO CHANGE WITHOUT NOTICE

NH 824 >> AFTERMARKET REPLACEMENT CORN HEAD PARTS

PART NUMBER	DESCRIPTION	PRICE	
JM645120	Yoke & Sprocket Weld Assembly	\$238.28	
JM645124	Divider Weld Assembly	Call for Pricing and Availability	
JM645848	RH 824 Corn Head Bracket (To fit 890, 892, 900)	\$100.72	
JM645870	#40 USA Chain (93 pitches)	\$39.35	
JM645962	LH 824 Corn Head Bracket (718, 782, 790)	\$106.00	
JM645963	RH 824 Corn Head Bracket (718, 782, 790)	\$100.72	
JM681678	Bracket Assembly NEW!	\$17.02	
JM646010	LH 824 Corn Head Bracket (890,892, 900)	\$344.25	
JM646361	RH Bracket	\$12.00	
JM646362	LH Bracket	\$12.00	
JM646418	Bracket & Bushing Assembly	\$64.22	

PRICES SUBJECT TO CHANGE WITHOUT NOTICE

717.464.1043

NH 824 >> ROW CROP – GATHERING CHAINS AND CUTOFF GROUP OUTSIDE ROWS (RH & LH are the same for except items with red stars *)

REFER- ENCE	PART NUMBER	QTY	DESCRIPTION	PRICE
1	JM644591	1	GATHERING CHAIN – CA620, 64 Total Pitches, Comes with Connector Link	\$286.38
1a	JM620A	AR	LOWER CHAIN CONNECTOR LINK [NOT PICTURED]	\$7.50
1b	JMCA620	AR	CONNECTOR LINK WITH EAR [NOT PICTURED]	\$19.57
2	JM646525	1	WEAR STRIP – R.H. 21.8" Long, Comes with Bolts *	\$80.36
2a	JM646524	1	WEAR STRIP – L.H. 21.8" Long, Comes with Bolts *	\$80.36
3	JM646360	1	WEAR STRIP – 8.75" Long, Comes with Bolts	\$29.93
4	JM680729	2	CHAIN GUIDE – Comes with Bolts	\$14.52
5	JM644201	2	IDLER SPROCKET ASSEMBLY – 10 Tooth, Includes Ref. 6, 7	\$222.76
6	JM66553	3	BALL BEARING – 203KRR2	\$21.82
7	JM12084	3	SNAP RING	\$8.95
8	JM87365	AR	WASHER – 5/8	\$0.21
9	JM138728	5	CAP – .28" Deep, (60mm) Diameter	\$9.81
10	JM645145	2	SPACER	\$9.21
11	JM644515	2	CAP – .78" Deep, 2 3/4" Diameter	\$15.96
12	JM645433	2	WASHER – 2 Straight Sides, 1 1/2" Diameter	\$4.30
13	JM234567	3	WASHER – 2 Straight Sides, 2 1/4" Diameter	\$7.92
14	JM280119	2	CAP SCREW – Hex Head, GR. 5, 5/8" x 3 1/2", with Lock Washer and Hex Nut	\$3.19
15	JM645266	1	IDLER BRACKET AND ROD ASSEMBLY – with 1 pc. 5/8 Jam Nut and 1pc. 5/8 Hex Nut	\$21.70
16	JM645212	1	SPACER WELD ASSEMBLY – (Used)	Call for Availability
17	JM685291	2	SPRING	\$44.03
18	JM645365	1	OUTER SHOE WELD ASSEMBLY – (Used)	\$100.00
19	JM644102	1	SPROCKET ASSEMBLY – 11 Tooth, Includes Ref. 20	\$369.11
20	JM644202	1	BUSHING	\$60.50
21	JM856146	1	SHAFT – 9.81" Long, R.H. *	\$92.91
21a	JM856144	1	SHAFT – 9.25" Long, L.H. *	\$92.91
22	JM26096	1	WASHER – 2.5" O.D. .187" Thick	\$10.77
23	JM701519	2	SEAL – 2" O.D.	\$15.46
24	JM218230	1	BEARING CUP AND CONE ASSEMBLY – LM67048 Timken Brg., LM67010 Race	\$21.23
25	JM618966	5	SPECIAL STEPPED WASHER	\$11.09
26	JM644474	1	SPACER – .75" Long	\$12.60
27	JM36723T	3	BEARING CUP – LM67010 Timken	\$5.28
28	JM48198	3	BEARING CONE AND SEAL – (LM67000LA-901AI) Timken	\$21.19
29	JM644100	1	SPROCKET – 11 Tooth, Splined I.D.	\$295.80
30	JM36313	1	SNAP RING	\$35.57
31	JM33212	AR	WASHER – .036" – (0.9mm) 1 1/4 I.D.	\$1.00
31a	JM708756	AR	WASHER – .010" – (.25mm) 1 1/4 I.D.	\$1.00
32	JM287370	2	DISC HOLDER WELD ASSEMBLY	\$120.31
33	JM86633666	2	CUT-OFF DISC	\$179.76
33a	JM87263	4	PLOW BOLT – 3/8" x 1 1/4"	\$0.35
33b	JM88682	8	CARRIAGE BOLT – Gr. 5, 3/8" x 1"	\$0.15
33c	JM80680	12	LOCKWASHER – 3/8"	\$0.10
33d	JM84944	12	HEX NUT – 3/8"	\$0.15
34	JM692300	2	HARDENED WASHER – 0.25" Thick x 2" O.D.	\$25.14
35	JM88551	2	CAP SCREW – Hex Head, Gr. 5, 1/2" x 1 3/4"	\$0.74
36	JM579925	4	PLATE	\$6.48
37	JM146258	AR	WASHER – 1 3/4" O.D., .060" Thick, 1 1/4 I.D.	\$4.85
38	JM645618	1	DIVIDER DRIVE SPROCKET – 22 Tooth *	\$31.83
38a	JM25283	1	SQUARE KEY – 1/4" x 7/8"	\$0.74
39	JM64053	2	HARDENED WASHER – 1 1/2" O.D., .160" Thick	\$2.94
40	JM87446	3	SLOTTED NUT – 5/8" UNF	\$2.28
40a	JM87395	3	COTTER PIN – 1/8" x 1 1/4"	\$0.28
41	JM685133	1	LOWER GATHERING CHAIN – CA620, 48 Total Pitches, Comes with Conn. Link	\$192.13
42	JM138741	1	IDLER SPROCKET	Call for Price
43	JM26382	AR	WASHER – 1.09" O.D., .060 Thick	\$1.73
44	JM678422	1	ADJUSTING ROD WELD ASSEMBLY	\$19.70
45	JM42973	1	RETAINING RING	\$57.15

AR=As Required

PRICES SUBJECT TO CHANGE WITHOUT NOTICE

NH 824 >> ROW CROP - OUTSIDE ROWS (Both are the Same)

REFERENCE	PART NUMBER	QTY	DESCRIPTION	PRICE
46	JM224245	1	WASHER	\$9.95
47	JM686730	1	ADJUSTER	\$45.75
48	JM686389	1	STRIPPER WELD ASSEMBLY LH *	\$29.70
48	JM686388	1	STRIPPER WELD ASSEMBLY RH *	\$29.70
49	JM675355	1	SHIELD WELD ASSEMBLY	\$29.80
50	JM685461	1	CAP LH ONLY *	\$64.95
51	JM646903	1	SUPPORT WELD ASSEMBLY	\$30.11

NOTE

Quantity used for one side only, for example, if you have a 2 row, always take 2 times the quantity specified except items with red star *.

Please let us know how you like our new "exploded" parts photos showing how to assemble! We are open to suggestions!



NH 824 >> ROW CROP – GATHERING CHAINS AND CUTOFF GROUP

CENTER ROW (RH & LH are the same for except items with red stars *)

REFER- ENCE	PART NUMBER	QTY	DESCRIPTION	PRICE
1	JM640148	1	GATHERING CHAIN – CA620, 58 Total Pitches, Comes with Conn. Link	\$286.38
2	JM646523	1	WEAR STRIP – Comes with Bolts	\$75.55
3	JM645222	1	SHOE WELD ASSEMBLY – R.H. (Used) *	\$75.00
3a	JM645218	1	SHOE WELD ASSEMBLY – L.H. (Used) *	\$75.00
4	JM645215	1	IDLER BRACKET AND ROD WELD ASSEMBLY	\$22.75
5	JM644201	2	IDLER SPROCKET ASSEMBLY – 10 Tooth, Includes Ref. 6, 7	\$222.76
6	JM66553	3	BALL BEARING – 203KRR2	\$21.82
7	JM12084	3	SNAP RING	\$8.95
8	JM87365	AR	WASHER – 5/8	\$0.21
9	JM138728	5	CAP – .28" Deep, (60mm) Diameter	\$9.81
10	JM645145	2	SPACER	\$9.21
11	JM644515	2	CAP – .78" Deep, 2 3/4" Diameter	\$15.96
12	JM645433	2	WASHER – 2 Straight Sides, 1 1/2" Diameter	\$4.30
13	JM234567	3	WASHER – 2 Straight Sides, 2 1/4" Diameter	\$7.92
14	JM280119	2	CAP SCREW – Hex Head, GR. 5, 5/8" x 3 1/2", with Lock Washer and Hex Nut	\$3.19
15	JM678687	1	SPACER WELD ASSEMBLY (Used)	\$14.00
16	JM195640	1	WASHER	\$5.75
17	JM685291	1	SPRING	\$44.03
18	JM644199	1	SPROCKET WELD ASSEMBLY – 9 Tooth and 18 Tooth	\$342.20
19	JM132709	1	BEARING CUP – L44610 Timken	\$8.65
20	JM132710	1	BEARING CONE – L44643 Timken	\$11.75
21	JM701519	1	OIL SEAL	\$15.46
22	JM605170	1	BEARING CUP – LM11710 Timken	\$7.58
23	JM605171	1	BEARING CONE – LM11749 Timken	\$16.34
24	JM13400	1	WASHER – .25" Thick	\$0.80
25	JM644595	1	SHAFT – 6 1/4" Long	\$157.62
26	JM618086	1	WASHER – 1.3" O.D., .25" Thick	\$0.80
27	JM87670	1	CAP SCREW – Hex Head, Gr. 5, 1/2" x 1 1/4"	\$0.65
28	JM644465	1	HUB – NEW	\$96.84
28a	JM80768	1	WOODRUFF KEY – #15, 1/4" x 1"	\$1.28
29	JM645614	3	SPRING WASHER	\$36.85
30	JM678424	2	WASHER	\$13.15
31	JM9827767	2	FRICITION DISC	\$18.50
32	JM644466	1	SPROCKET – 22 Tooth	\$35.45
33	JM639328	1	LOCKWASHER	\$62.64
34	JM698154	1	LOCKNUT – 1 3/4" – 18	\$84.27
35	JM856145	1	SHAFT – 9" Long	\$71.00
36	JM44914	1	SPACER – 1" Long	\$10.30
37	JM146258	AR	WASHER – 1.75" O.D. 0.06" Thick x 1 1/4" I.D.	\$4.85
38	JM644469	1	CAP – .59" Deep, 3 1/8" O.D.	Call for Availability
39	JM618966	1	SPECIAL STEP WASHER	\$11.09
41	JM48198	3	BEARING CONE & SEAL – LM67000 LA-90241 Timken	\$21.19
42	JM36723T	4	LM67010 TIMKEN RACE	\$5.28
43	JM86633666	2	CUT OFF DISC	\$179.76
44	JM579925	4	CLEAN OFF PLATE (Used)	\$6.48
45	JM287370	2	DISC HOLDER WELD ASSEMBLY	\$120.31
46	JM692300	2	HARDENED WASHER – ASN 738416 JM574245	\$25.14
47	JM88551	2	1/2 x 1 3/4 Gr. 5 HH Bolt – ASN 738416 JM285585	\$0.74
48	JM33212	AR	WASHER – 0.036" Thick x 1 1/4" I.D.	\$1.00
48a	JM708756	AR	WASHER – 0.010" Thick x 1 1/4" I.D.	\$1.00
49	JM36313	1	SNAP RING	\$35.57
50	JM688398	1	RETAINER WASHER	\$27.46

AR=As Required

PRICES SUBJECT TO CHANGE WITHOUT NOTICE

NOTE

Quantity used for one side only, for example, if you have a 2 row, always take 2 times the quantity specified except items with red star *.

Please let us know how you like our new "exploded" parts photos showing how to assemble! We are open to suggestions!

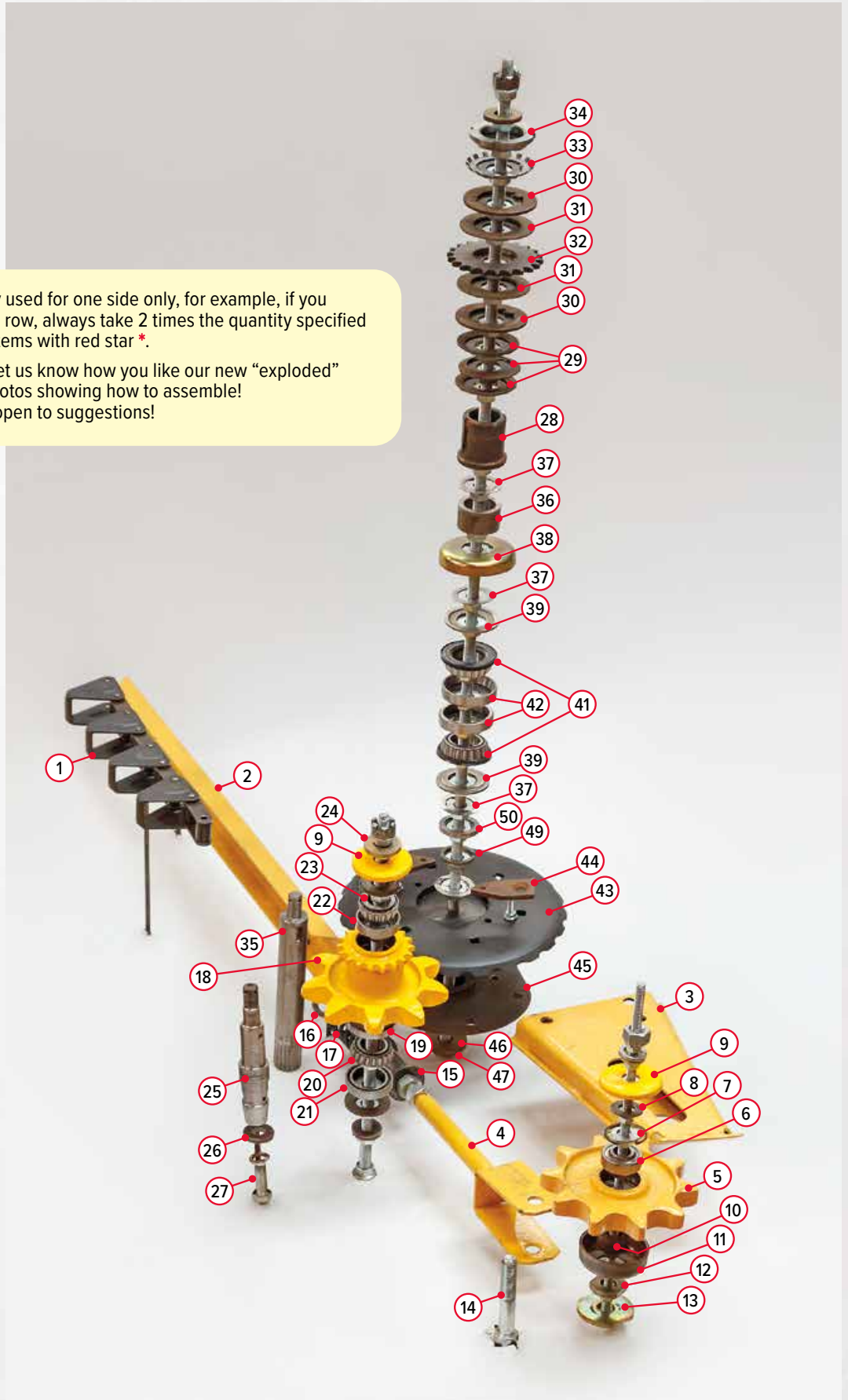

PRICES SUBJECT TO CHANGE WITHOUT NOTICE

717.464.1043

NH 824 >> ROW CROP MAIN DRIVE GROUP

REFERENCE	PART NUMBER	QTY	DESCRIPTION	PRICE
1	JM572735	1	SPROCKET WELD ASSEMBLY – 20 Tooth	\$52.00
1a	JM572734	1	SPROCKET WELD ASSEMBLY – 26 Tooth	\$52.00
1b	JM52736	1	SPROCKET WELD ASSEMBLY – 30 Tooth	\$55.00
1c	JM611785	1	SPROCKET WELD ASSEMBLY – 34 Tooth	\$59.57
2	JM46520	1	SHEAR BOLT WITH LOCKNUT – Pkg. of 10	\$6.10
3	JM572421	1	SHEAR HUB WELD ASSEMBLY	\$64.87
4	JM572894	AR	WASHER – 2" O.D., .075" Thick, 1 ⁵ / ₁₆ " I.D.	\$1.77
5	JM214539	AR	WASHER – 1 ³ / ₄ " O.D., .020" Thick, 1 ⁵ / ₁₆ " I.D.	\$1.96
6	JM146258	AR	WASHER – 1 ³ / ₄ " O.D., .060" Thick, 1 ¹ / ₄ " I.D.	\$4.85
7	JM80754	2	COTTER PIN – ³ / ₁₆ " x 1 ¹ / ₂ "	\$0.60
8	JM763338	1	HEX SHAFT – 37 ³ / ₄ " Long (Replaces JM644893) – Uses ¹ / ₄ " Cotter Pin	\$68.54
9	JM578189	4	FLANGETTE	\$3.81
10	JM121602	3	BALL BEARING – Hex Bore	\$39.60
11	JM644895	1 or 2	SPACER – 3.56" Long	\$22.92
12	JM719563	2	BEVEL GEAR – 15 Tooth, Hex Bore	\$176.41
13	JM691097	1	BEARING HOUSING ASSEMBLY – Includes Red. 10 and 21 (Used)	\$180.00
14	JM644474	1	SPACER – .75" Long	\$12.60
15	JM572891	2	SPACER – .937" Long	\$1.70
17	JM782447	1	GEAR – 20 Tooth, Hex Bore	\$136.61
18	JM782446	1	GEAR – 20 Tooth, Splined Bore	\$136.61
19	JM644894	1	SHAFT – 16 ³ / ₄ " Long	\$96.00
21	JM45882	2	BALL BEARING – SA206-18FP7, with Locking Collar	\$22.50
22	JM691100	1	BEARING HOUSING ASSEMBLY – Includes Ref. 23 (Used)	\$130.00
23	JM38766	1	BALL BEARING – SA206-20FP7, 1 ¹ / ₄ ", with Locking Collar	\$26.09
25	JM43048	2	FLANGETTE	\$4.19
26	JM719565	6	BEVEL GEAR – 15 Tooth, Splined Bore	\$213.15
27	JM244638	4	RETAINING RING	\$11.16
28	JM33212	AR	WASHER – 1.75" – 0.036" Thick, 1 ¹ / ₄ " I.D.	\$1.00
29	JM618966	6	SPECIAL STEPPED WASHER	\$11.09
30	JM48198	6	BEARING CONE AND SEAL – LM67000 LA-902A1 Timken	\$21.19
31	JM36723T	6	BEARING CUP – LM67010 Timken	\$5.28
32	JM644973	2	SPACER – .906" Long	\$6.85
34	JM644470	2	SHAFT – 7.31" Long	\$65.75
35	JM218230	2	BEARING CUP AND CONE ASSEMBLY – LM67048-LM67010 Timken	\$21.23
36	JM707374	2	BEARING RING (Old Style)	\$24.13
36A	JM774773	2	BEARING RING (New Style)	\$69.66
37	JM9623892	2	7-TOOTH SPLINE SPROCKET (New Style)	\$82.07
37A	JM694005	2	7-TOOTH SPLINE SPROCKET (Old Style)	Call for Price
38	JM707373	2	PLASTIC COLLAR – Only Used on Old Style	\$24.13
39	JM64053	4	HARDENED WASHER	\$2.94
40	JM87446	4	SLOTTED NUT – ⁵ / ₈ " UNF	\$2.28
40a	JM87395	4	COTTER PIN – ¹ / ₈ " x 1 ¹ / ₄ " – Center Shafts Also Need	\$0.28
41	JM685461	2	COVER – 3 ¹ / ₈ " O.D.	\$64.95
42	JM690503	2	SEAL – 1.877" O.D., Only Used on New Style	\$9.80
42A	JM616414	2	OIL SEAL	\$4.35
43	JM644107	4	SPROCKET – 7 Tooth	\$80.40

Verify which one you want.

AR=As Required

PRICES SUBJECT TO CHANGE WITHOUT NOTICE

REFERENCE	PART NUMBER	QTY	DESCRIPTION	PRICE
43a	JM47471	4	HALF MOON WOODRUFF KEY – #15, 1/4" x 1" [LOWER KEY NOT PICTURED]	\$0.70
44	JM685462	2	SPACER – 1.75" Long	\$26.59
45	JM644974	2	SPACER – .562" Long	\$12.04
46	JM644463	2	SHAFT – 10 1/8" Long	\$73.00
47	JM88980	4	NIPPLE – 1/8" x 4 3/4"	\$1.50
48	JM124160	2	NIPPLE – 1/8" x 2 1/2"	\$2.14
53	JM572893	1	SPACER – 3/8" Long	\$1.06
54	JM197631	1	HEX BORE BUSHING	\$29.56

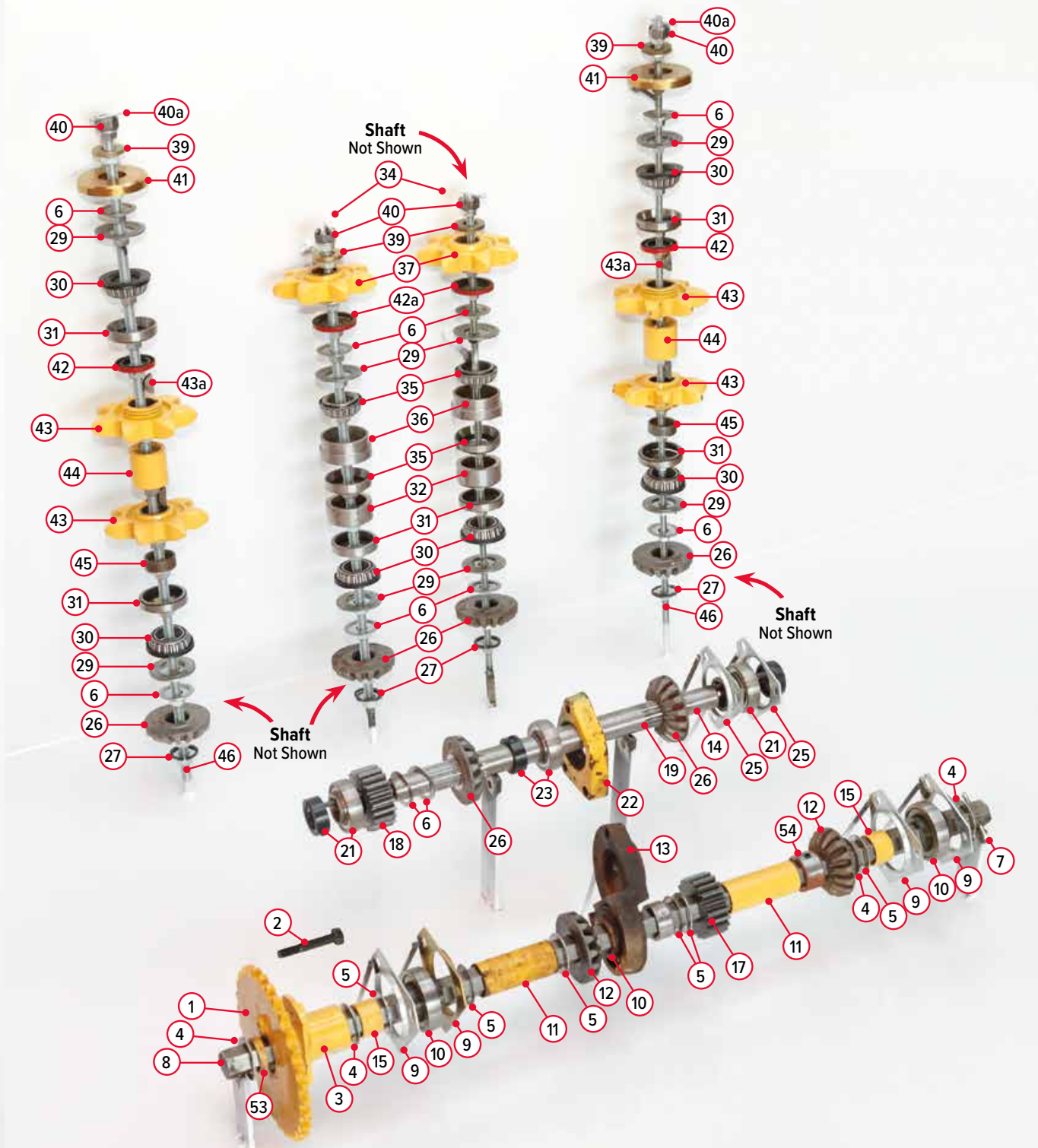

NH 824 >> AFTERMARKET REPLACEMENT CORN HEAD PARTS

PART NUMBER	DESCRIPTION	PRICE	
JM646942	Shield	\$21.10	
JM646966	Shield	\$18.91	
JM680728	LH Angle	\$12.15	
JM8067	<p>Complete Set of 824 Wear Strips</p> <p>Includes: 2 pc. JM646360, 2 pc. JM646523, 1 pc. JM646524, 1 pc. JM646525, 4 pc. JM680729</p> <p><i>We are updating the wear-resistant on all our 824 wear strips. They are now hardened to outlast a set of chain!</i></p>	\$453.25	

PRICES SUBJECT TO CHANGE WITHOUT NOTICE

717.464.1043

NH 360N3, 360N4, 360N6 » AFTERMARKET REPLACEMENT CORN HEAD PARTS ALSO ALL 3 PN HEADS



New Holland® is a Registered Trademark of CNH Industrial America LLC which does not manufacture or endorse these parts.

EASY REFERENCE CHART

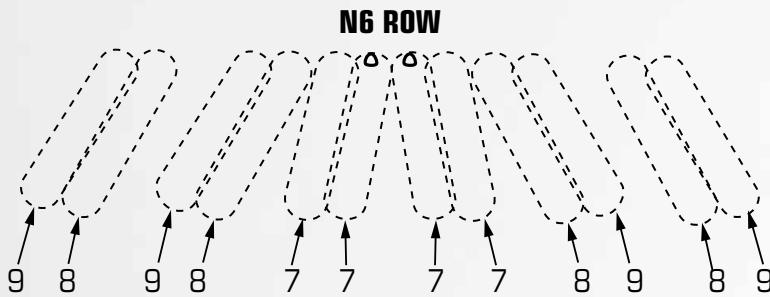
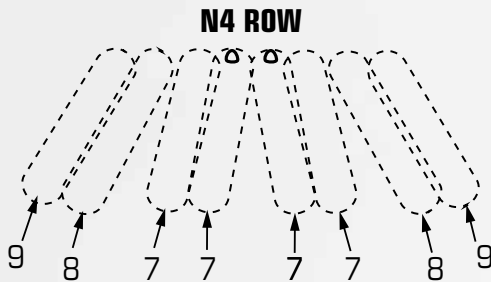
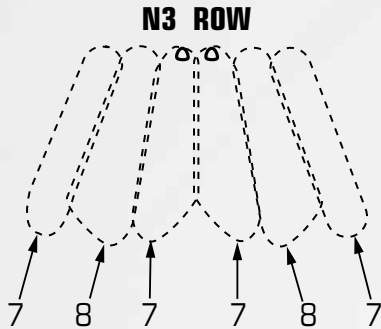

We have a handy and easy way to order the chain you need!

	PRICE
Reference #7 JM9842118, 92 Pitch	\$468.20
Reference #8 JM9842120, 96 Pitch	\$493.00
Reference #9 JM9842119, 88 Pitch	\$435.00

Complete Corn Head Chain Prices

	PRICE
3 Row	\$2858.00
4 Row	\$3728.80
6 Row	\$5584.00

Imagine!
**This is the Real Drives USA
Corn Head Chain!**

**Chain shipping connections a problem?
Call us. We can help!**



**Whether you have a 3, 4, or 6 row corn head, we can rebuild it!
We do appreciate having them in the wintertime to rebuild!
Most of the sprockets now available in aftermarket. Call with your needs!**

PRICES SUBJECT TO CHANGE WITHOUT NOTICE

JOE'S MACHINERY LLC

AFTERMARKET REPLACEMENT NH 360 N 3-4-6 ROW » CORN HEAD PARTS
AFTERMARKET REPLACEMENT NH 3PN N 3 ROW » CORN HEAD PARTS

PART NUMBER	DESCRIPTION	PRICE	
JM86621657	Part # Substitutes 9615268 Spline Drive Sprocket	\$246.94	
	QTY USED: 360N3 3 pc.		
	360N4 4 pc.		
	360N6 4 pc.		
	3PN 3 pc.		
JM86631929	Drive Sprocket w/Keyway	\$239.00	
	QTY USED: 360N3 3 pc.		
	360N4 4 pc.		
	360N6 6 pc.		
	3PN 3 pc.		
JM86631930	Part # Substitutes 9827863 14 Tooth Idler Sprocket	\$129.74	
	QTY USED: 360N3 4 pc.		
	360N4 6 pc.		
	360N6 10 pc.		
	3PN 4 pc.		
JM86631931	Part # Substitutes 9827097 13 Tooth Idler Sprocket	\$125.53	
	QTY USED: 360N3 2 pc.		
	360N4 2 pc.		
	360N6 4 pc.		
	3PN 2 pc.		
JM86631932	Part # Substitutes 9615281-9849883 Sprocket with Power Divider Mount	\$181.25	
	QTY USED: 360N3 2 pc.		
	360N4 2 pc.		
	360N6 2 pc.		
	3PN 2 pc.		
JM86631939	Part # Substitutes 9615280-86500918 Top Drive Sprocket	\$133.24	
	QTY USED: 360N3 4 pc.		
	360N4 6 pc.		
	360N6 10 pc.		
	3PN 4 pc.		

PRICES SUBJECT TO CHANGE WITHOUT NOTICE

717.464.1043

NH 360N3, 360N4, 360N6 » AFTERMARKET REPLACEMENT CORN HEAD PARTS

PART NUMBER	DESCRIPTION	PRICE	
JM120041	Short Neck Carriage CL 8.8 M 10 x 1.5 x 20	\$1.20	
JM121092	Spring Washer	\$53.61	
JM121602	Hex Ball Bearing 2AH07-11/8	\$39.60	
JM143760	Drive Sprocket	\$74.00	
JM164936	#60 USA Chain 62 Pitch with Conn. Link on Main Drive	\$67.65	
JM169670	#60 USA Chain 72 Pitch With Conn. Link for Auger	\$75.74	
JM269060	Sleeve on Hex Shaft	\$45.72	
JM272730	Snap Ring	\$23.40	
JM275246	Cam Subs to 84819985	\$11.62	
JM288875	Oil Seal	\$4.86	
JM325424	Bolt NEW! HHCL 8.8-M12 x 1.75 x 130	\$2.33	
JM330760	Washer	\$20.54	
JM370008	Snap Ring (M50)	\$6.73	
JM386510	External Spring	\$10.43	
JM386511	Internal Spring	\$11.53	
JM38766	Bearing Insert - FYH SA206-20FP9 or FP7 Used on 824 cornheads, NH harvester augers, and more	\$26.09	

PRICES SUBJECT TO CHANGE WITHOUT NOTICE

NH 360N3, 360N4, 360N6 » AFTERMARKET REPLACEMENT CORN HEAD PARTS

PART NUMBER	DESCRIPTION	PRICE		
JM412674	HHCL 8.8 M 12 x 1.25 x 50 Bolt	\$2.09		
JM43138	HHCL 8.8 M 10 x 1.5 x 20 Bolt	\$2.09		
JM43140	HHCL 8.8 M 10 x 1.5 x 30 Bolt	\$2.09		
JM43260	HHCL 10.9 x M 12 x 1.75 x 30 Bolt	\$2.09	[PHOTO NOT AVAILABLE]	
JM46810	Snap Ring	\$7.42	[PHOTO NOT AVAILABLE]	
JM47066	Bearing Insert FYH SA207-22 FP7 Non-greasable (1 $\frac{3}{8}$ bore) For long PTO shafts on NH harvesters (782-790-890-892)	\$33.46		
JM47618652	Friction Disc for Bower (Same as part #127434 and #65049)	\$55.87	<i>Also fits most NH hay heads!</i>	
JM49683	Clutch Plate	\$25.32		
JM576253	Clutch Plate	\$67.30		
JM66967	Snap Ring	\$5.53		
JM719563	Bevel Gear 15 Tooth	\$176.41		
JM8068	3PN Operator's Manual	\$26.70		
JM856297	Hex Shaft Subs to 86633851	Call for Price		
JM86536900	3-Hole Bracket on Slip Disc	\$11.00		
JM856379	Hex Shaft RH	Call for Price		
JM859687	Shaft 19 $\frac{1}{2}$ " long	\$149.50		 <i>For 900 Chopper</i>
JM8603209	Snap Ring NEW!	\$7.42		
JM86500943	Cover Cap	\$59.06		

PRICES SUBJECT TO CHANGE WITHOUT NOTICE

717.464.1043

NH 360N3, 360N4, 360N6 >> AFTERMARKET REPLACEMENT CORN HEAD PARTS

PART NUMBER	DESCRIPTION	PRICE	
JM86500945	Wear Strip on LH and RH Side	\$70.53	
JM86520197	#80 USA Chain 80 Pltch with 1 Connector, 4 Offset Links (Row Unit Drive)	\$186.76	
JM86528900	Nose	\$224.00	
JM86528913	Nose Tip	\$99.72	
JM86550248	Spring Washer	Call for Availability	
JM86621578	Outside RH Nose	\$131.91	
JM86631723RH	Fender RH	\$234.00	
JM86705943	Fender LH	\$234.00	
JM86621580	Inside LH Nose	\$131.91	
JM86624516	RH Throat Plate	\$256.43	
JM86624518	LH Throat Plate	\$161.07	
JM86624579	Angle Stripper	\$39.55	

PRICES SUBJECT TO CHANGE WITHOUT NOTICE

NH 360N3, 360N4, 360N6 >> AFTERMARKET REPLACEMENT CORN HEAD PARTS

PART NUMBER	DESCRIPTION	PRICE	
JM86627129	Clutch Plate	\$99.78	
JM86633816	17" Long Shaft For heads to fit FP230-FP240	\$149.50	[PHOTO NOT AVAILABLE]
JM86633840	Torsion Spring	\$30.48	
JM9615260	Hub	\$124.80	
JM9615266	Spacer	\$15.79	
JM9615267	Washer	\$68.58	
JM9615293	Dog Pin	\$6.00	
JM9615294	Dog Subs to 86633847	\$35.20	
JM9617470	Wear Strip in Center Rows	\$56.74	
JM9619666	Plate on Power Divider	\$20.44	
JM9622548	Bevel Gear 15 Tooth	\$187.56	
JM9800740	Ball Bearing 6010-2NSE9	\$38.88	
JM9807906	Ball Bearing NTN11811	\$18.90	
JM980822	Extension Floor for 360N3	Call for Availability	[PHOTO NOT AVAILABLE]
JM9808272	Drive Sprocket <i>Bring your hub in and we put a new sprocket on.</i>	Call for Pricing.	
JM9808503	Bearing Housing	Call for Pricing.	[PHOTO NOT AVAILABLE]
JM980907	#60 USA Chain 68 Pitch with 1 Connector (Row Unit Drive)	\$69.61	

PRICES SUBJECT TO CHANGE WITHOUT NOTICE

717.464.1043

NH 360N3, 360N4, 360N6 >> AFTERMARKET REPLACEMENT CORN HEAD PARTS

PART NUMBER	DESCRIPTION	PRICE		
JM9822651	Washer	\$20.37		
JM9822696	Disc Shaft	\$201.54		
JM9822697	Disc Shaft	\$201.54		
JM9822699	Housing	\$239.25		
JM9825157	Seal	\$45.67		
JM9825158	Seal Ring NEW!	\$54.19		
JM9827867	Cover Cap	\$27.55		
JM9827884	Cover Cap	\$34.18		
JM9827885	Sleeve	\$16.99		
JM9828106	Compression Spring	\$8.42		
JM9843298	Extension Floor for 360N4	Call for Pricing and Availability	[PHOTO NOT AVAILABLE]	
JM9843538	Cutting Disc	\$185.00		
JM9845441	Stalk Sweeper	\$4.95		
JM9847988	Hex Shaft LH	\$94.79		
JM9849886	Power Divider	\$108.00		

PRICES SUBJECT TO CHANGE WITHOUT NOTICE

NH 790W, 890W, 900W, 990W, 27P, 29P >> AFTERMARKET REPLACEMENT HAY HEAD PARTS

New Holland® is a Registered Trademark of CNH Industrial America LLC which does not manufacture or endorse these parts.

PART NUMBER	DESCRIPTION	PRICE	
JM131673	Steel Teeth	\$2.57	
JM134526	Poly Pick-up Band <i>Your hay head runs much quieter!</i>	\$35.00	
JM134921	Steel Teeth Tine Spacer	\$7.29	
JM136137	Steel Teeth Bolt Bracket (Used)	\$3.00	
JM136544	LH Crop Guide on 900W for 892 Harvester Subs to 86624831 Fits 990W, 27P, 29P	\$112.50	
JM136545	RH Crop Guide on 900W for 892 Harvester Subs to 86624829 Fits 990W, 27P, 29P	\$132.13	
JM136554	Tine Bar (Takes 4) Fits 900 only	\$92.22	
JM8658801	29P Tine Bar (Takes 4) Fits 29P only	\$92.22	
JM9807938	27P Tine Bar (Takes 4) Fits 27P, 990	\$104.99	
JM9800710	Tine Bar (Takes 3) Fits 890 only	\$85.82	
JM29860	Pin on 900W, 990W	\$6.70	
JM288799	Finger Guide	\$8.96	
JM29840	Spring on 900W, 990W	\$6.68	
JM47577168	Tine Bar Bearing (8212 + N)	\$26.65	

PRICES SUBJECT TO CHANGE WITHOUT NOTICE

717.464.1043

PART NUMBER	DESCRIPTION	PRICE		
JM47618652	Friction Disc for Hay Head (Same as part #127434 and #65049)	\$55.87		
JM54695	Tine Bar Bearing Flange	\$10.50		
JM703995	LH Crop Guide on 790W, 890W	Call for Availability On a Used One		
JM703996	RH Crop Guide on 790W, 890W	\$140.16		
JM8069	Hay Head Used Steel Pick-up Bands	\$12.00		
JM854415	LH Crop Guide on 900W for 900 Harvester	\$195.56		
JM854416	RH Crop Guide on 900W for 900 Harvester	\$180.55		
JM86536275	Cam Bearing <i>Always check your stud size and specify if it is either 3/8" or 1/2"</i>	\$18.07		
JM87642989	Steel Teeth Bolt	\$3.57		
JM9846006	Hay Head Long Arm	\$108.01		
JM9847572	Rubber Teeth Fits 27P, 29P	\$14.02		

PRICES SUBJECT TO CHANGE WITHOUT NOTICE

NH 717 & 718 » AFTERMARKET REPLACEMENT HARVESTER PARTS

New Holland® is a Registered Trademark of CNH Industrial America LLC which does not manufacture or endorse these parts.

PART NUMBER	DESCRIPTION	PRICE		
JM12124	Ball Bearing on Front at PTO	\$42.25		
JM121506	Bearing and Race Assembly LM29749-29710	\$42.03		
JM121961	C71 Belt For 717-718 reversing gearbox (takes 2)	\$41.91		
JM121969	Clutch Yoke 1875 Series on 717 Check cross & brg. measurement	\$314.50		
JM164012	Clutch Yoke 35 Series on S717	\$314.50		
JM709318	Clutch Yoke 35 Series on 718	\$314.50		
JM122288	24 Tooth Length of Cut Sprocket	\$106.91		
JM122288A	34 Tooth Length of Cut Sprocket To drive feedroll slower	\$101.86		
JM122296	Smooth Roll (for 717-718-770)	\$184.45		
JM122397	Smooth Roll Sprocket	\$111.69		
JM122418	14 Tooth Length of Cut Sprocket	\$87.50		
JM122420	Drive Shaft Beside Smooth Rail	\$97.50		
JM122456	717 only Single Edge Knife	\$158.00		
JM122459	Upper Front Feedroll Straight Spline Sprocket On 717 and S717 BSN 168904 and 770 BSN 166380	\$155.61		
JM122474	Feedroll Spring with Insert - Bolt	\$70.45		

PRICES SUBJECT TO CHANGE WITHOUT NOTICE

717.464.1043

NH 717 & 718 » AFTERMARKET REPLACEMENT HARVESTER PARTS

PART NUMBER	DESCRIPTION	PRICE		
JM122506	Spring Nut Fits JM122474	\$26.61		
JM122510	Bottom Front Feedroll Shaft	\$93.20		
JM122522	4" Wide 717 only Sharpener Shield	\$16.65		
JM122718	Slip Disc (No Spline) (#M970-1700)	\$59.06		
JM126219	Thrower Paddle on Cutterhead	\$16.00		
JM126760	718 Slip Disc Bushing	\$39.68		
JM128840	Gear with Shaft	\$113.57		
JM131354	Gearbox Chain Guide	\$63.46		
JM131356	Scraper With Notch (for 717 and S717 before serial #179756)	\$107.89		
JM131491	Spacer on Slip Clutch	\$6.85		
JM131867	Large Adjustable Nut For shear bar. Fits Older Chopper.	\$57.39		
JM131907	Shear Bar Bolt (3¾" long) Used on 717 ASN 4300 and 717S BSN 179756	\$11.76		
JM131976	717 Scraper Support Plate	\$30.36		
JM131998	Scraper Bolt on 717 and S717 BSN 179756 ½" x 1¼ Ft. Bolt	\$6.36		
JM132898	Sprocket and Yoke Weld Assembly	\$223.65		

PRICES SUBJECT TO CHANGE WITHOUT NOTICE













NH 717 & 718 » AFTERMARKET REPLACEMENT HARVESTER PARTS

PART NUMBER	DESCRIPTION	PRICE		
JM137930	30 Tooth Length of Cut Sprocket Bottom front feedroll sprocket	\$87.30		
JM137931	17-32 Tooth Sprocket Table DR NEW!	\$95.09		
JM143479	9/16 Knife Bolt Washer	\$1.90		
JM165354	Front 35's Yoke (on main shaft) When calling for this front PTO yoke, always get us a yoke width measurement.	\$239.25		
JM165384	1 1/4 PTO Shaft (Long)	\$395.72		
JM166300	Oil Seal on Wheel	\$15.20		
JM179462	Smooth Roll Scraper (for 718-770 also for S717 after serial #179757)	\$116.56		
JM179469	Shear Bar Hold Down	\$23.50		
JM179470	Shear Bar Adjuster Nut	\$22.95		
JM179483	Sharpening Stone (round wheel, same as 890)	\$40.70		
JM179923	770 Smooth Roll Drive Sprocket	\$274.89	[PHOTO NOT AVAILABLE]	
JM183999	Shear Bar Cone Washer On adjuster nut	\$8.10		
JM214419	770 Cutterhead Sprocket	\$85.75		
JM216973	Knives, Double Edged, Hardfaced	\$148.09		
JM225925	Upper Front Feedroll Taper Spline Sprocket On S717 ASN 168905, and 718-782-790, and 770 ASN 166381	\$164.84		

PRICES SUBJECT TO CHANGE WITHOUT NOTICE

717.464.1043

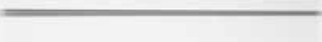
NH 717 & 718 » AFTERMARKET REPLACEMENT HARVESTER PARTS

PART NUMBER	DESCRIPTION	PRICE		
JM234569	718 Override Clutch Snap Ring	\$14.80		
JM237519	717-718-770 Shear Bar	\$194.00		
JM8070	Shear Bar Bolts: use 2 pc. 1/2 x 3/4" and 1/2 x 2" Fine Thread Bolt	\$2.31		
JM241375	Smooth Roll Shaft (for 717-718-770) Fits into JM122296 Smooth Roll	\$91.00		
JM249845	718 Cutterhead Drive Washer	\$8.82		
JM253110	718 only Sharpener Shield	\$70.30		
JM253162	717-718 Blower Band	\$255.00		
JM253187	Support at Transition	\$77.36		
JM253434	Pin 717-718 Tongue NEW!	\$12.86		
JM254297	Cutterhead Plastic Collar Fits 718, 782, 790, 717	\$24.46		
JM254411	Upper Feedroll Universal with Shaft with Shear Pin Kit Bolts to straight gear <i>With shear pin kit so you can save the universal joints!</i> Uses JM58118 Shear Pin	\$265.94		
JM257102	1 3/8 PTO Shaft	\$436.14		
JM261798	Slip Disc (With Spline)	\$141.76		
JM285333	Angle Behind Feedroll	\$32.00		

PRICES SUBJECT TO CHANGE WITHOUT NOTICE













NH 717 & 718 » AFTERMARKET REPLACEMENT HARVESTER PARTS

PART NUMBER	DESCRIPTION	PRICE		
JM286527	718 Feedroll Spring	\$77.70		
JM35116	Knife Bolt, 5/16" x 1 1/4", Gr. 8, F.T.	\$1.60		
JM35664	Stone Holder Cap	\$111.30		
JM36725T	Race LM11910 Timken Race	\$3.96		
JM46442	Long Stone Holder Pipe	\$21.25		JM46443 
JM46443	Short Stone Holder Pipe	\$15.50		
JM46789	Dog Pin	\$9.20		
JM46826	717 Cutterhead Yoke Bushing	\$88.04		
JM46889	717-718 Sprocket Bearing Needle NEW!	\$9.75		
JM56704	Bushing	\$62.60		
JM574171	Aftermarket Replacement Bushing on Feedroll Side Plates	\$9.80		
JM122604	Sharpener Handle	\$18.35		
JM611447	Upper Rear Feedroll Fits all 717-718-770	\$362.23		
JM67372	Bearing LM11900 LA with Seal Goes on part #JM128840 shaft	\$18.62		
JM688048	Gooseneck Hold Down on 790 BSN 759354 on 900 BSN 781114	\$12.40		
JM717-718	Table DR Chain NEW! Includes 1 offset and 1 conn link	\$54.89		
JM718556	Cutterhead Yoke 35 Series	\$625.35		

PRICES SUBJECT TO CHANGE WITHOUT NOTICE

717.464.1043

NH 717 & 718 » AFTERMARKET REPLACEMENT HARVESTER PARTS

PART NUMBER	DESCRIPTION	PRICE		
JM80223439	Sharpener Kicker	\$12.51		
JM80303	717 Weld On Pc. <i>NEW!</i> ASN 4300 and some 5712 Fits large adj. nut 13167	\$75.00		
JM80304	717, 782, & 770 Weld On Pc. <i>NEW!</i> Fits adj. nut 17470	\$65.00		
JM81305	Shear Bar Holder <i>NEW!</i> Welded to Chopper Frame	\$145.65		
JM8071	Steel Goosenecks for 717, 718, 782, 790, 890, 892, 900 - They all fit the same This goosneck has no adjustment. <i>For more goosneck information, check out the Goosneck page!</i>	\$485.84		
JM8072	770 Fan Paddles - Set of 3	\$130.00		
JM86558574	Sharpener Slip Disc	\$25.90		
JM86629486	Dog On Cutterhead Drive	\$77.87		
JM87847	Scraper Bolt without Hole 718-770-S.717 ASN. 179757	\$1.50		
JM88417	1/2 x 4 1/4 G.R. 8 Machined Used BSN 4299 on 717	\$18.57		
JM88849	Shear Bar Bolt 1/2 x 3 Gr. 8 ft. Bolt and Washer. S717 ASN179757	\$1.70		
JM88852	718 Shear Bar Bolt (1/2 x 3 1/4 ft. Gr. 8)	\$1.57		

PRICES SUBJECT TO CHANGE WITHOUT NOTICE

PART NUMBER	DESCRIPTION	PRICE	
JM9617868	Spring	\$15.43	
JM9619931	Sharpening Stone (same as 892 and 782) Comes packaged with two O-Rings	\$40.52	
JM49658	717-718 Gear Box Chain	\$36.86	[PHOTO NOT AVAILABLE]

NH 717-718 BOX BEARINGS, RACES, OIL SEALS

For Prices go to Bearings Pages

717 REVERSING GEAR BOX			
Timken	New Holland	Qty.	Description
JMB2012	168109	1	Needle Bearing
JMB2016	36312	2	Needle Bearing
JM34056	37857	3	Seal
JM202820	126987	1	Needle Bearing
JMB208	46889	2	Needle Bearing
JM343186	36310	2	Seal
JM40140S	126986	1	Seal

JOINT ASSEMBLY FOR HEAD DRIVE			
Timken	New Holland	Qty.	Description
JMLM67000	481198	1	Bearing
JM67010	36723	2	Race
JM67048	36726	1	Bearing
JM11900	67372	2	Bearing
JM11910	36725	2	Race

717 ANGLE GEAR BOX			
Timken	New Holland	Qty.	Description
JM471192	28246	2	Seal
JM48510	48976	3	Race
JMLM48548	48977	3	Bearing
JM67048	36726	1	Bearing
JM67010	36723	1	Race

718 ANGLE GEAR BOX			
Timken	New Holland	Qty.	Description
CALL	8656512015	1	Bearing Assembly – Includes Race
JM471192	28246	1	Seal
JMM86610	CODW4616A	1	Race
JMM86649	CODW4621A	1	Bearing
JM2788	41480	1	Bearing
JM2735X	50515	1	Race

PRICES SUBJECT TO CHANGE WITHOUT NOTICE

717.464.1043

NH 782 & 790 » AFTERMARKET REPLACEMENT HARVESTER PARTS

New Holland® is a Registered Trademark of CNH Industrial America LLC which does not manufacture or endorse these parts.

PART NUMBER	DESCRIPTION	PRICE	
JM103243	Auger Idler Sprocket 4017 5/8 Bore NEW!	\$25.03	
JM105259	Cable Bushing	\$3.87	
JM110660	Reversing Gearbox Spring Fits 717-718-770-782-790	\$80.77	
JM110680	Ball in Reversing Gearbox	\$9.37	
JM12124	Ball Bearing (on front at PTO)	\$42.25	
JM122397	Smooth Roll Sprocket	\$111.69	
JM122469	Upper Feedroll Drive Chain USA CA550 (21 pitches) (1 offset and 1 connector)	\$71.61	
JM122476	Collar on Feedroll Sideplate Fits 717-718-770-782-790	\$4.90	
JM122503	Lift Roller with Bushing	\$55.00	
JM122956	Auger Sprocket Bushing <i>Like original quality now!</i>	\$14.80	
JM126003	Stake Nut on Cutterhead	\$47.11	
JM128375	Jack Pin w/ Spring and Roll Pin	\$15.26	
JM132898	Sprocket and Yoke Weld Assembly	\$223.65	
JM136684	Gooseneck Turner Nut	\$30.98	
JM136696	Steel Deflector Spacers	\$4.50	
JM136978	Flangett for Long PTO Shaft	\$4.66	

PRICES SUBJECT TO CHANGE WITHOUT NOTICE

PART NUMBER	DESCRIPTION	PRICE	
JM137930	30 Tooth Length of Cut Sprocket Bottom Front Feedroll Sprocket	\$87.30	
JM13911	Lift Roller Spacer	\$12.42	
JM143479	718-782 Shear Bar Washer (Also fits S717 ASN 179757) (Is same as 718 Knife Bolt Washer)	\$1.90	
JM179470	Shear Bar Adjuster Nut	\$22.95	
JM179965	Sprocket Assembly on Auger (with bushing)	\$56.94	
JM183999	Shear Bar Cone Washer On Adjuster Nut	\$8.10	
JM189392	782 Transition Used on all 782 choppers and 790 BSN 759354	\$667.17	
JM196287	Snap Ring on Angle Gearbox	\$34.18	
JM213565	Hub on Center on Long Shaft	\$79.93	
JM216850	Idler Sprocket 5017 x 1/2 bore For Long Reversing Gearbox Chain	\$32.98	
JM218983	Needle Bearing	\$20.52	
JM224895	New Gearbox Reverser Motor Bigger and Heavier	\$358.00	
JM226196	Cutterhead PTO Pin	\$41.66	

PRICES SUBJECT TO CHANGE WITHOUT NOTICE

PART NUMBER	DESCRIPTION	PRICE	
JM229542	USA #50 Chain, Long Reversing Gearbox Chain (112 pitches)	\$75.11	
JM243157	782 Cutterhead Female PTO	\$198.75	
JM244245	Snap Ring on Shear Pin Yoke	\$9.69	
JM245743	Shield and Bearing Support on Auger Bearing	\$10.55	
JM253168	Spline Hub and Bushing	\$126.52	
JM253768	USA #40 Auger Chain (140 pitches)	\$72.20	
JM254146	Side Plate Center Bushing	\$4.45	
JM254297	Cutterhead Plastic Collar (fits 782 or 790) 717-718	\$24.46	
JM26558	Washer in Shear Pin Yoke	\$1.87	
JM272688	Override Bearing on 790 Angle Gear Box NEW!	\$60.86	
JM280656	Special Fan Paddle Bolt with nut, flat, and lock washer (1 pc.)	\$5.55	
JM280700	Set of 6 bolts	\$33.30 per set of 6	
JM280732	Gr. 8 FT⁵/₈ x 1¹/₂ Bolt (fits 790 knife)	\$0.93	
JM28110	Insulator Rope Guide NEW!	\$7.58	
JM28114	U Bolt for Gooseneck Insulator NEW!	\$2.24	
JM28256	Hub Bushing	\$14.55	













PRICES SUBJECT TO CHANGE WITHOUT NOTICE

PART NUMBER	DESCRIPTION	PRICE	
JM285836	Spindle (for 782-790) (Also fits 890-892)	\$180.12	
JM32809	Spring on Hitch	\$135.10	
JM35664	782 Stone Holder Cap	\$111.30	
JM36312	Needle Bearing	\$32.49	
JM36314	Lower Feedroll Drive Chain USA #50 (44 pitches)	\$36.63	
JM36622	Feedroll Side Plate Washer Fits 717-718-770-782-790	\$1.35	
JM37185	Snap Ring At front PTO yoke	\$14.73	
JM37857	Oil Seal 2 pc. per reversing gearbox	\$8.98	
JM43048	3 Hole 1 1/4 Bearing Flange on Auger	\$4.19	
JM46520	Shear Pin (for cutterhead and auger) (10/pk)	\$6.10	
JM46047	Shear Pin (used on 790 Choppers after serial #812592)	11.55	
JM467820	Limit Switch	\$44.81	
JM46826	Cutterhead Yoke Bushing	\$88.04	
JM574171	Aftermarket Replacement Bushing on Feedroll Side Plates	\$9.80	
JM575988	Spring Blower Belt Tension Spring	\$23.58	
JM578727	782, 790 Auger Uses JM38766 Bearing Insert	\$398.00	

PRICES SUBJECT TO CHANGE WITHOUT NOTICE

717.464.1043

NH 782 & 790 » AFTERMARKET REPLACEMENT HARVESTER PARTS

PART NUMBER	DESCRIPTION	PRICE	
JM578738	782 or 790 Auger Housing only (not like original) Weld onto your auger ends.	\$143.10	
JM578743	Front Auger Sheet	\$91.40	
JM578790	Cutterhead Bottom (Weld in) NEW! 782-790	\$44.14	
JM578806	Yoke with Shear Pin Plate For JM46520 Shear Pin For 782 and on 790 BSN 812591	\$279.34	
JM9619690	Yoke for JM46047 Shear Pin ASN 812592	\$177.97	
JM578801	782-790 Auger Lid	\$186.73	
JM578826	Blower Front Panel with Bearing Holder	\$665.60	
JM579364	C 60 Belt for Reversing Gearbox (2 pieces)	\$37.72	
JM58118	Shear Pin (for feedrolls)	\$6.93	
JM602641	J-Bolt on Lid	\$22.40	
JM602996	Deflector Switch 3 Prong	\$10.99	
JM621425	782 Cutterhead Male PTO with Shear Pin Setup Also fits 790 BSN 812591	\$115.74	
JM627384	Sprocket Weld Assembly (on non-metal alert)	\$100.91	
JM627387	Shaft Weld Assembly – 26 Tooth Sprocket	\$93.68	

PRICES SUBJECT TO CHANGE WITHOUT NOTICE

NH 782 & 790 » AFTERMARKET REPLACEMENT HARVESTER PARTS

PART NUMBER	DESCRIPTION	PRICE		
JM638297	782 Knife, Spiral, Double Edged	\$132.31		
JM640091	782 1000RPM Belt (Blower)	\$111.51		
JM646056	Bushing for Gooseneck Hold Down	\$4.77		
JM66460	Idler Pulley	\$89.36		
JM66553	Bearing on Transmission Idler Pulley	\$21.82		
JM677563	790 Female Plug - Harvester End	\$120.63		
JM762836	790 Male Plug - Control Box End	\$101.91		
JM682360	Power Rocker Switch Fits 790 - 900	\$114.00		
JM682361	Feedroll Rocker Switch Fits 790 - 900	\$113.00		
JM686539	Upper Rear Feedroll	\$305.28		
JM700411	Feedroll Cable Pulley Bushing Fits 718-782-790	\$17.80		
JM700493	Wire Cable for Feedroll	\$27.20		
JM700905	Clutch in Reversing Gearbox Fits 782-790 Only	\$258.75		
JM700914	Feedroll Tension Spring	\$102.62		
JM701316	782 or 790 Smooth Roll Scraper	\$98.06		
JM701317	782 or 790 Scraper Support	\$26.59		
JM701519	Oil Seal on Gear Box	\$15.46		











PRICES SUBJECT TO CHANGE WITHOUT NOTICE

717.464.1043

PART NUMBER	DESCRIPTION	PRICE		
JM702034	Triple Length of Cut Sprocket	\$185.50		
JM702743	Lever Latch	\$64.49		
JM702847	Cutterhead Lid	\$60.85		
JM703244	Shaft for Head Drive	\$71.41		
JM703727	Bracket on Long PTO	\$34.45		
JM703728	1 3/8 PTO Shaft	\$345.03		
JM703784	Bushing in Shear Pin Yoke	\$9.01		
JM704580	782 Knife Block (used)	\$15.90		
JM710450	Guard at Cutterhead PTO (782 or 790)	\$50.99		
JM710984	Sprocket Weld Assembly (with 2pc. JM36951 bushing)	\$137.95		
JM713229	Yoke Weld Assembly (for metal alert and non-metal alert units)	\$352.79		
JM713551	782 Stone Holder	\$101.01		
JM715782	782 540 RPM Belt	\$105.12		
JM716163	Cutterhead Sprocket	\$62.36		

PRICES SUBJECT TO CHANGE WITHOUT NOTICE













NH 782 & 790 » AFTERMARKET REPLACEMENT HARVESTER PARTS

PART NUMBER	DESCRIPTION	PRICE		
JM716164	Auger Idler Bracket	\$38.82		
JM764785	782 or 790 Smooth Roll Always order 2 pc. JM9013 Bearing Insert	\$256.52		
JM768235	790 Stone Holder	\$101.01		
JM768236	790 Stone Holder Cap	\$111.30		
JM768242	Long Stone Holder Pipe	\$20.67		
JM782790	New Style Drive Line Kit for Upper Feedrolls on 782 & 790 Harvesters for Non-metal and Metalalart mfg. with 12 Series Universal Yokes.	\$595.00	<i>If you are tired of your yoke pins and bolts just breaking, then try this!</i>	
JM78279010	Hydraulic Tongue Swing Kit for NH 782 & 790 Harvesters Includes all hoses <i>Like the original!</i>	\$715.49		
JM784239	RH Crop Guide with Bolts	\$44.79		
JM784240	LH Crop Guide with Bolts	\$44.79		
JM784247	RH Feedroll Side Plate (with our bushings) <i>Our bushings are now built like original</i>	\$187.22		
JM784248	LH Feedroll Side Plate (with our bushings)	\$169.61		
JM784540	Cutterhead Yoke at Magnet	\$658.74		
JM784651	790 Spiral Knife (single edge)	\$81.00		

PRICES SUBJECT TO CHANGE WITHOUT NOTICE

717.464.1043

NH 782 & 790 » AFTERMARKET REPLACEMENT HARVESTER PARTS

PART NUMBER	DESCRIPTION	PRICE		
JM784964	Sharpener Rail	\$168.16		
JM786144	Sharpener Handle	\$19.26		
JM786489	Electric Magnet	\$1004.85		
JM784652	790 Knife Block (used)	\$15.90		
JM791531	Auger Lid Hinges	\$7.10		
JM796623	790 1000RPM Belt (Blower)	\$189.95		
JM796624	790 540RPM Belt (Blower)	\$202.54		
JM798096	782 or 790 Blower Band	\$187.00		
JM80138243	Gooseneck Turner Nut Pin	\$24.48		
JM80700464	Bottom Front Feedroll (non metal alert)	\$476.30		
JM8076	790 Operator Manual	\$42.93		
JM8077	790 Tandem Kit Per Side without Wheels It only fits on LH side if you use a 2 row corn head.	\$391.11		
JM8078RH	R.H. Torsion Axle for 790	\$270.97		
JM8078LH	L.H. Torsion Axle for 790	\$270.97		

PRICES SUBJECT TO CHANGE WITHOUT NOTICE

NH 782 & 790 >> AFTERMARKET REPLACEMENT HARVESTER PARTS

PART NUMBER	DESCRIPTION	PRICE		
JM8079	790 Support Pole for Gooseneck	\$933.23		
JM850079	Inner Reversing Gear Box Shaft	\$310.80		JM850735
JM850735	Outer Reversing Gear Box Shaft	\$234.94		
JM86515794	Electric Deflector Motor Bracket w/ Hardware	\$85.70		
JM851709	790 Shear Bar Adjuster Rod	\$35.81		
JM851797	Short Stone Holder Pipe	\$14.31		
JM853905	782-790 Rear Blower Sheet	\$266.40		
JM857262	782 & 790 Star	\$166.56		
JM857264	Fan Shaft Weld Assembly (782 or 790)	\$231.90		JM857758
JM857758	782 or 790 Fan Paddle - Set of 3 (cupped for much better blowing)	\$130.00 per set of 3		
JM86509454	790 Shearbar Bolt 1/2 x 3 1/4" Gr.8 bolt and 1/2" Lock Washer and Washer	\$1.70		
JM86516721	Spout Switch 6 Prong	\$19.14		
JM86528652	Gr. 8 Washer on Knife Bolt (fits all harvesters)	\$1.80		

PRICES SUBJECT TO CHANGE WITHOUT NOTICE

717.464.1043

PART NUMBER	DESCRIPTION	PRICE	
JM86620779	Steel Spout Deflector	\$59.46	
JM86621454	Clean Out Cover	\$10.62	
JM86636511	Wing Nut on Lids	\$12.59	
JM859331	790 Cutterhead Female PTO	\$195.67	
JM86518367	Electric Deflector Motor	\$231.11	
JM86558574	Sharpener Slip Disk	\$25.90	
JM86593050	Yoke & Gear 35 Series	\$570.00	
JM86622143	Steel Spout Deflector Spring	\$8.73	
JM86622174	Bracket	\$16.56	
JM86635853	Blower Band J Bolt	\$19.29	
JM86641949	790 Knife Baffle	\$18.02	
JM86979736	Drive Line Spacer NEW!	\$16.10	
JM88246	Gr. 8 FT 5/8 x 1 1/4 Bolt (fits 782 knife)	\$ 1.60	
JM88849	782 Shear Bar Bolt 1/2 x 3 Gr.8 Ft. (Also fits S717 ASN 179757)	\$1.70	
JM9610799	782 or 790 Shear Bar Original OEM with aftermarket replacement price!	\$244.20	
JM9616873	Cone Washer	\$9.86	

PRICES SUBJECT TO CHANGE WITHOUT NOTICE

PART NUMBER	DESCRIPTION	PRICE		
JM9617912	Plate for Feedroll Cable Fits 718-782-790	\$6.81		
JM9616874	Cone Washer	\$9.86		
JM9619688	790 Cutterhead Male PTO with Shear Pin Setup (Only ASN 812592)	\$135.11		
JM9619871	790 Sharpening Stone (same as 900) Comes packaged with 4 O-Rings	\$58.60		
JM9619931	782 Sharpening Stone (same as 892) Comes packaged with 2 O-Rings	\$40.52		
JM9623519	Pin on 790-FP230-240 and 900 ASN 751185	\$17.62		
JM9804623	Actuator on 790 Only	\$495.00		
JM9824963	Transition with Flat Top Between serial numbers 759355 - 967211	\$549.13	<i>Always Specify Flat Top or Pipe Style</i>	
JM86591668	Transition with Flat Top ASN 967212 This plate has a different hole pattern	\$694.53		
JM9827836	Kicker Bracket on Sharpener	\$79.16		

NH 782-790 BOX BEARINGS, RACES, OIL SEALS

For Prices go to Bearings Pages

782-790 ANGLE GEAR BOX			
Timken	New Holland	Qty.	Description
JM473231	137547	1	Seal
JM25520	86900365	1	Race
JM60349	67527	1	Bearing
JM603011	67526	1	Race
JM473313	196286	1	Seal
JMLM501349	86652015	1	Bearing
JMLM501310	Assembly	1	Race
JM473277	272545	1	Seal
JM25580	13540	1	Bearing
JM3782	Assy 86537517	1	Bearing

782-790 REVERSING GEAR BOX			
Timken	New Holland	Qty.	Description
JM10163	701519	2	Seal
JM67010	36723	2	Race
JM67048	36726	2	Bearing
JM34056	37857	2	Seal
JMB2016	36312	2	Bearing
JMJH1818	218983	1	Bearing

PRICES SUBJECT TO CHANGE WITHOUT NOTICE

717.464.1043

CHOPPER LENGTH OF CUT CHARTS

782 – 790 LENGTH OF CUT				
Amount Knives				
	12	8	6	3
15 Tooth Sprocket	1/8 cut	3/16	1/4	1/2
27	1/4	3/8	1/2	1
39	3/8	9/16	3/4	1 1/2

The 15, 27, 39 tooth sprocket is the triple sprocket on forward and reversing gearbox.

717 – 718 LENGTH OF CUT					
Amount Knives					
		12	6	3	2
Front Sprocket 14	Rear Sprocket 30	1/8 cut	1/4	1/2	3/4
14	24	5/32	5/16	5/8	15/16
24	30	7/32	7/16	7/8	1 15/16
30	24	11/32	11/16	1 3/8	2 1/16
24	14	15/32	15/16	1 7/8	2 13/16
30	14	5/8	1 1/4	2 1/2	3 3/4

890 – 892 LENGTH OF CUT				
Amount Knives				
	12	8	6	3
13 Tooth Sprocket	1/8 cut	3/16	1/4	1/2
23	1/4	3/8	1/2	1
32	3/8	9/16	3/4	1 1/2

The 13, 23, 32 tooth sprocket is the triple sprocket on forward and reversing gearbox.

900 LENGTH OF CUT			
Amount Knives			
	12	8	6
12 Tooth Sprocket	3/16 cut	9/32	3/8
19	1/4	3/8	1/2
26	3/8	9/16	3/4
30	7/16	21/32	7/8









The 12, 19, 26, 30 tooth sprockets are 2 different double sprockets on forward and reverse gearbox.

PRICES SUBJECT TO CHANGE WITHOUT NOTICE

JOE'S MACHINERY LLC

NH 880, 1880, & 1900 >> AFTERMARKET REPLACEMENT HARVESTER PARTS & MISC.

New Holland® is a Registered Trademark of CNH Industrial America LLC which does not manufacture or endorse these parts.

PART NUMBER	DESCRIPTION	PRICE	
JM136912	Smooth Roll Shaft Only on Old Style 880 Smooth roll	\$118.00	
JM137264	Smooth Roll Scraper BSN89197 Scraper is Angle Iron Only	\$146.05	
JM237273	Smooth Roll Only on Old Style 880	\$212.75	
JM237274	880-1880 Smooth Roll on New Style	\$317.09	
JM244770	Smooth Roll Scraper ASN. 89198 Scraper has a bushing weld on.	\$146.05	
JM263840	Blower Band for 880-1880	\$249.60	
JM264000	880 Shear Bar with Holder NEW! <i>Can be used on all 880-1880 Harvesters</i> Uses JM237521 Shear Bar	\$229.40	
JM600368	1900 Smooth Roll	\$418.70	
JM8081	1900 Shear Bar Adjuster Nut	\$36.02	
JM8082	IH 720-830 Harvester Blower Band	\$255.30	
JM8083	NH36-38 Flail Chopper Band	\$220.80	
JM856197	NH 1900 Upper Rear Feed Roll	\$675.00	
JM9846532	1900 Smooth Roll Scraper	\$178.72	

PRICES SUBJECT TO CHANGE WITHOUT NOTICE

717.464.1043

NH 890 & 892 » AFTERMARKET REPLACEMENT HARVESTER PARTS

New Holland® is a Registered Trademark of CNH Industrial America LLC which does not manufacture or endorse these parts.

PART NUMBER	DESCRIPTION	PRICE	
JM103244	5017 Idler Sprocket (5/8" bore) For on auger	\$38.10	
JM12124	Ball Bearing (6210 LU) On front at PTO	\$42.25	
JM122397	892 Smooth Roll Sprocket	\$111.69	
JM122397A	890 Smooth Roll Sprocket		
JM122432	Washer on Upper Feedroll	\$2.66	
JM122469	Upper Feedroll Drive Chain USA CA550 (21 pitches) (1 offset - 1 connector)	\$71.61	
JM122506	Spring Nut For 890 spring	\$26.61	
JM128375	Jack Pin With spring and roll pin	\$15.26	
JM131998	Feedroll Bolt with Wire Hole	\$6.36	
JM132759	Grommet (Idler Shock)	\$25.99	
JM136771	Oil Seal (2 per gearbox) Reversing	\$8.42	
JM136801	Stake Nut For on cutter head	\$38.04	
JM136909	Special Feedroll Washer	\$13.80	
JM136919	Yoke and Sprocket Assembly (at upper rear feed roll)	\$262.00	
JM136920	13 Tooth Sprocket on Top Front Roll Used	\$142.21	
JM136978	Flangette For long PTO shaft	\$4.66	
JM137388	Pin to Fasten Head	\$12.98	

PRICES SUBJECT TO CHANGE WITHOUT NOTICE

PART NUMBER	DESCRIPTION	PRICE		
JM137389	Block Pivot	\$135.77	<i>We have used ones for \$25.00</i>	
JM141492	Bushing for JM224644 Roller NEW!	\$1.06		
JM165584	Head Roller with Bushing	\$223.05		
JM165585	Head Roller Bushing	\$34.79		
JM166300	Wheel Oil Seal	\$15.20		
JM169703	Spring Crank Assembly	\$30.00		
JM174980	Auger Drive Chain USA #50 (118 pitches)	\$93.23		
JM179483	Sharpener Stone (for 890)	\$40.70		
JM179541	Plate Weld Assembly (on bottom front feedroll)	\$19.29		
JM185746	Bearing Quarter For PTO shield on front (Takes 4 per end)	\$8.03 each		
JM189168	Spring Cover	\$79.84		
JM214784	890 Sharpener Bearing	\$138.75		
JM223316	Stone Carrier Bushing	\$12.88		
JM224265	19 Tooth Gear for 892 Reversing Gearbox with Bushing	\$245.73		
JM224270	Triple Groove Tranny Pulley	\$209.88		
JM224354	890 Sharpener Belt	\$16.98		

PRICES SUBJECT TO CHANGE WITHOUT NOTICE

717.464.1043

NH 890 & 892 » AFTERMARKET REPLACEMENT HARVESTER PARTS

PART NUMBER	DESCRIPTION	PRICE	IMAGE	
JM224355	Clutch Disc (sharpener) Takes 1 pc. on each side of sharpener gear on cutterhead	\$25.25		
JM224392	Reverse Spline Bracket	\$31.55		
JM224400	Washer on Sharpener Reversing Clutch	\$5.94		
JM224420	Reversing Gearbox Bushing	\$32.44		
JM224424	Shifter Bar	\$12.95		
JM224427	Transmission Clutch Pin	\$13.98		
JM224435	Clutch Plate Weld Assembly Inside Transmission	\$489.33		
JM224644	Roller Assembly (for transmission shifter)	\$10.49		
JM224775	Shaft and Sprocket Weld Assembly From long chain to smooth roll	\$117.92		
JM224924	Long Tranny Chain Idler Sprocket	\$100.34		
JM225083	Shear Bar Holder	\$193.98		
JM225387	890, 892 Blower Band Wear Liner (stainless steel) Comes with bolts	\$126.50		
JM225396	890, 892 Blower Band Also fits 900 – FP230 – FP240	\$224.28		
JM225481	Auger Trough (not like original) Welded onto your auger ends	\$205.00		

PRICES SUBJECT TO CHANGE WITHOUT NOTICE

PART NUMBER	DESCRIPTION	PRICE	
JM225482	890-892 Auger Lid Comes with hinges	\$235.09	
JM225678	Cutterhead Sprocket For auger chain	\$188.29	
JM225679	Auger Sprocket with Bushing (on auger)	\$75.42	
JM226079	892 Angle Gearbox Rebuilt with new bearings & races, seals, etc.	Call for Pricing	
JM227794	890,892 Smooth Roll Scraper	\$124.80	
JM228016	Special Washer (tapered) For shear bar adjuster bolt	\$7.63	
JM228017	Adjuster Nut (for shear bar)	\$26.03	
JM229751	Cover At shear bar ends	\$12.00	
JM229928	Bracket with Bolt For on JM224924	\$34.47	
JM237257	Large Spring (transmission spring)	\$39.64	
JM237262	Thrust Bearing Inside reversing gearbox	\$46.00	
JM237521	890, 892 Shear Bar with Bolts	\$255.00	
JM237805	Head Roller Spacer	\$13.80	
JM238158	Plate on Blower	\$20.85	
JM238159	Paddle Arm	\$33.07	

PRICES SUBJECT TO CHANGE WITHOUT NOTICE

717.464.1043

NH 890 & 892 » AFTERMARKET REPLACEMENT HARVESTER PARTS

PART NUMBER	DESCRIPTION	PRICE		
JM238160	892 Blower Bushing	\$3.97	JM238160	JM238163
JM238163	Special Blower Bolt with Zerk	\$18.02		
JM238166	Fan Star	\$243.53		
JM238321	890, 892 Fan Paddle (set of 3)	\$130.00 per set of 3		
JM242307	Matched Belt Set on Transmission Drive (B62) (3 pieces)	\$21.50 each		
JM242715	Rubber Feed Roll Pad	\$7.50		
JM242716	Clip on Feed Roll Pad	\$6.08		
JM243120	Front Ball Bearing Flange Holder on 12'5" Shaft	\$29.94		
JM243121	Center Ball Bearing Flange Holder on 12'5" Shaft	\$29.94		
JM243725	890 Knife	\$142.00		
JM244169	Front Blower Panel	\$213.38	JM244169	JM244170
JM244170	Rear Blower Panel	\$213.38		
JM244179	Yoke on Angle Gearbox Towards PTO (890-892)	\$390.89		

PRICES SUBJECT TO CHANGE WITHOUT NOTICE

PART NUMBER	DESCRIPTION	PRICE	
JM244180	Yoke on Rear of Long PTO	\$270.62	
JM244245	Snap Ring on Shear Pin Yoke	\$9.69	
JM244246	Rear Ball Bearing Flange Holder on 12'5" Shaft	\$35.78	
JM244247	LH Adapter Plate (at smooth roll)	\$15.37	
JM244248	RH Adapter Plate (at smooth roll)	\$15.37	
JM244379	Shear Bar Bolt Washer	\$6.62	
JM244638	Snap Ring (for transmission shaft)	\$11.16	
JM245201	Top Transmission Sprocket and Yoke	\$230.86	
JM245743	Shield and Bearing Support on Auger Bearing	\$10.55	
JM249128	Feedroll Hubcap	\$7.40	
JM254073	Small Spring (at transmission)	\$24.88	
JM255097	Bottom Front Bearing and Housing	\$42.00	
JM257260	Spring (890 feedroll spring) (bolt - insert included)	\$69.56	

PRICES SUBJECT TO CHANGE WITHOUT NOTICE

PART NUMBER	DESCRIPTION	PRICE		
JM265351	Front Sheet (with slots) Between blower and cutterhead. The 3 slots let in air for better blowing!	113.95		
JM265352	Bracket Weld Assembly	\$43.19		
JM27276	Small Transmission Clutch Washer (To space clutch plates)	\$0.50		
JM27503	Snap Ring (for transmission clutch pack)	\$9.10		
JM27767	Bushing on Spline Sleeve	\$9.01		
JM280340	5/8 x 3 1/2 Gr. 8 Bolt FT HH for Shear Bar	\$5.53		
JM280656	Special Fan Paddle Bolt (with nut, flat, & lockwasher)	\$5.55 each		
JM280700	Set of 6 bolts	\$33.30		
JM280499	1/2" Bolt Transition NEW! (Short Neck)	\$0.76		
JM285836	Spindle Weld Assembly Also fits 782-790 choppers	\$180.12		
JM35664	Stone Holder Cap	\$111.30		
JM36314	Lower Feedroll Drive Chain USA #50 (44 pitches)	\$36.63		
JM37185	Snap Ring	\$14.73		
JM40293	Shifter Hole Bushing	\$50.91		
JM42019	Shifter Spring on Clutch Plate	\$5.94		
JM42447	Large Snap Ring on Front PTO Bearing	\$25.57		
JM43048	3-hole 1 1/4 Bearing Flange (on auger)	\$4.19		











PRICES SUBJECT TO CHANGE WITHOUT NOTICE

PART NUMBER	DESCRIPTION	PRICE	
JM46443	Short Stone Holder Pipe	\$15.50	
JM46520	Shear Pin (fits cutterhead and auger)	\$6.10 per pkg. of 10	
JM46566	Breather Plug	\$6.36	
JM47204	Transmission Snap Ring	\$35.98	
JM49683	Clutch Plate on Blower	\$25.32	
JM49684	Spring Cone (ask for used ones \$20.00 each)	\$42.33	
JM578788	Plate for Sharpener	\$5.96	
JM58118	Shear Pin (for feedroll) (10/pk.)	\$6.93	
JM601109	900 Side Plate Bushing	\$4.66	
JM603917	Upper Rear Feedroll	\$365.00	
JM604016	Cover 892 Sharpener NEW!	\$9.65	
JM606352	Threaded Cap on PTO	\$82.80	
JM619104	Bracket	\$34.53	
JM619107	Tongue Lever Pin	\$18.22	
JM619208	Front Bearing Housing	\$113.33	

PRICES SUBJECT TO CHANGE WITHOUT NOTICE

717.464.1043

NH 890 & 892 >> AFTERMARKET REPLACEMENT HARVESTER PARTS

PART NUMBER	DESCRIPTION	PRICE		
JM619226	Ball Bearing Flange Holder (2pc.) on 9'5" Shaft	\$29.94		
JM619288	Front Shield on PTO	\$48.78		
JM8080	Flighting Only (per foot)	\$43.46		
JM620490	Auger	\$502.26		
JM621425	Shear Pin Cutterhead Shaft	\$115.74		
JM623582	Washer on Blower	\$8.94		
JM627631	Rear Hitch Pin	\$31.91		
JM632289	LH Bearing Plate Assembly with Races (#JM36723+) Takes 4pc. JM48198 Bearing	\$217.84	 LH JM632289	
JM632290	RH Bearing Assembly with Races (#JM36723+) Takes 2pc. JM36726 Bearing and 2pc. JM48198 Bearing	\$235.51		
JM635411	892 Knife	\$160.00		
JM655892	892 Cutterhead Bottom NEW!	\$57.05		
JM66460	Idler Pulley On transmission belts	\$89.36		
JM65930	Aftermarket Replacement Bushing	\$9.25		

PRICES SUBJECT TO CHANGE WITHOUT NOTICE

PART NUMBER	DESCRIPTION	PRICE		
JM66553	Bearing on Transmission Idler Pulley	\$21.82		
JM66595	Clutch Driving Disc Assembly	\$46.63		
JM66807	Oil Seal (1 per gearbox)	\$7.44		
JM700685	9'5" Short PTO Shaft	\$395.00		
JM700758	12'5" Long PTO Shaft	\$460.00		
JM701593	Yoke with Shear Hub on Feed Roll Dr.	\$110.01		
JM702209	Length of Cut Sprocket	\$165.82		
JM704580	Knife Block (used)	\$15.00		
JM704585	892 Cutterhead	\$1700.00		
JM705279	Collar Goes on cutterhead shaft	\$38.48		
JM705854	LH Hook	\$14.65		
JM705855	RH Hook	\$14.65		
JM706617	Knob with Rod	\$21.33		
JM706646	890-892 Bottom Front Feedroll with 1/4 Shaft Includes two 1/4 bearing inserts, 2 adaptor plates, 1 pc. 5030 sprocket. Specify if table drive sprockets are needed.	\$514.00		
JM80305	Triple Sprocket NEW! for an original tapered spline bottom front feedroll. Use 1/2x4" Gr. 8 Bolt	\$188.00		
JM706712	Link Weld Assembly (On feed rolls)	\$28.35		

PRICES SUBJECT TO CHANGE WITHOUT NOTICE

717.464.1043

PART NUMBER	DESCRIPTION	PRICE	IMAGE	
JM706736	Cover Weld Assembly	\$132.76		
JM706739	Baffle in Front of Cutterhead	\$55.20		
JM706740	Left Hand Crop Guide With bolts	\$44.52	 JM706740	 JM706741
JM706741	Right Hand Crop Guide With bolts	\$44.52		
JM706742	Sharpener Shield	\$92.86		
JM707854	Shear Bar Bolt	\$7.50		
JM709971	Long Stone Holder Pipe	\$22.91		
JM710014	Inserts for P.T.O.	\$41.14		
JM712067	NH892 Handle Weld Assembly	\$51.37		
JM713551	Stone Holder	\$101.01		
JM713549	892 Carrier Shaft for Sharpener	\$206.06		
JM713555	Stone Carrier with Bushings	\$392.61		
JM715034	Sharpener Rail Weld Assembly w/ Kicker Bracket	\$128.26		

PRICES SUBJECT TO CHANGE WITHOUT NOTICE

PART NUMBER	DESCRIPTION	PRICE		
JM715499	30 Tooth Sprocket with Spline on Bottom Front Roll	\$134.67		
JM715964	890, 892 Smooth Roll	\$262.82		
JM716321	Shear Hub with Shaft on Feedroll	\$110.84		
JM716325	Universal Shaft Only	\$21.70		
JM718478	892 Sharpener Handle	\$18.39		
JM719026	Long Reversing Gearbox Chain USA #60 (96 pitches)	\$97.35		
JM719220	Spline Sleeve on Sharpener	\$126.45		
JM768239	Stone Holder Plug	\$2.95		
JM76877	Clevis Pin	\$1.64		
JM768987	Transition on 890-892	\$590.00		
JM791531	Auger Lid Hinges	\$7.10		
JM80306	892 Flat Transition Patch NEW!	\$16.59		
JM80307	Support 892 RH Auger Trough End NEW!	\$9.99		
JM80308	LH Auger Trough End 892 NEW!	\$38.61	 JM80308 LH	JM80309 RH 
JM80309	RH Auger Trough End 892 NEW!	\$33.87		

PRICES SUBJECT TO CHANGE WITHOUT NOTICE

PART NUMBER	DESCRIPTION	PRICE		
JM80310	Upright Transition Patch NEW!	\$17.45		
JM80311	Handle Cutterhead Cover NEW!	\$5.46		
JM80312	Wrench for Sharpener Cap NEW!	\$17.61		
JM80313	Shear Bar Block NEW! 890 892 Weld On	\$65.00		
JM80753	Tongue Lever Spring	\$5.96		
JM8085	892 Angle Gearbox Shaft Towards Cutterhead	\$214.45		
JM8086	892 Bottom Front Feedroll Shafts and Parts Including Sprockets	\$222.60		
JM8087	Shear Pin Kit on Blower <i>No more unknown clutch disk slippage! You can blow with full force!</i>	\$177.02		892 Front Top-Cover Hinges
JM8088	1 Set of 892 Front Top Cover Hinges	\$25.90		
JM8089	Aftermarket Replacement 890 Sharpener Cable Flex Shaft	\$330.00		
JM8089A	Shaft Only	\$106.65		
JM8090	Quick Pipe	\$115.33		
JM8091	Quick Clamp	\$67.34		
JM8092	Slip In Pipe	\$141.51		

PRICES SUBJECT TO CHANGE WITHOUT NOTICE

PART NUMBER	DESCRIPTION	PRICE		
JM86511977	5/16 x 18 x 3/4" Screw (for wear plate)	\$0.85 per piece		
		\$5.10 per set of 6		
JM86528652	890, 892 Knife Bolt Washer	\$1.80		
JM86593056	Yoke and Gear Weld Assembly (on main cutterhead) Takes JM-200-2600 Cross & Bearing Kit	\$648.00		
JM86631407	Clip on Feedroll Spring Crank and Jack Handle	\$31.19		
JM86635853	J - Bolt (for blower band)	\$19.29		
JM86635908	Feed Roll Spring Nut	\$38.72		
JM86635909	Used spring with new insert	\$112.56		
JM86635910	Used spring only - 17" long without nut	\$77.91		
JM86635908H	Spring Insert with Hook NEW! to replace when your spring breaks	\$62.49		
JM86636512	Blower Star Bushing	\$32.31		
JM86900816	Clutch Plate	\$16.69		
JM87054556	Idler Spring on Tranny Belts	\$59.26		
JM87446	Slot Nut on Upper Feedroll	\$2.28		
JM87658033	Shim for Sharpener Carrier Plate	\$5.32		
JM87696	Set Screw for JM122397 Sprocket	\$0.52		
JM87955	Roll Pin on Reversing Gear Box	\$0.97		
JM88246	5/8 x 1 1/4 UNF Gr. 8 Bolt (knife bolt)	\$1.60		

PRICES SUBJECT TO CHANGE WITHOUT NOTICE

PART NUMBER	DESCRIPTION	PRICE	
JM9618050	Tongue Lever	\$50.92	
JM9619931	Sharpening Stone (for 892) Comes packaged with 2 O-rings	\$40.52	
JM9809671	Yoke Pin	\$16.00	
JM9827836	Kicker Bracket	\$79.16	

NH 890-892 GEARBOX BEARINGS, RACES, OIL SEALS

For Prices go to Bearings Pages

892 ANGLE GEAR BOX

Timken	New Holland	Qty.	Description
JMCR16085	137547	1	Seal
JM22580	13540	2	Bearing
JM22520	13958	2	Race
JMM86649	214878	1	Bearing Assy.
INCLUDES JMM86610			Race
JM473313	196286	1	Seal
JMLM603011	67526	1	Bearing
JMLM603049	67527	1	Race
JM471288	225615	1	Seal

892 REVERSING GEAR BOX

Timken	New Holland	Qty.	Description
JM02820	72946	2	Race
JMT474278	136771	2	Seal
JMLM29749	121506	1	Bearing Assy.
JMLM29710	121506	1	Race
JM67048	36726	1	Bearing
JM470625	66807	1	Seal
JM02876	224556	2	Bearing
JMA252611	237262	2	Bearing
JMJH1818	218983	1	NE. Bearing

AG CHOICE APPLICATOR

This auger applicator is the way to go!

Holds an average of 50 lbs. with lightweight dry inoculant or almost 100 lbs. with high density inoculant

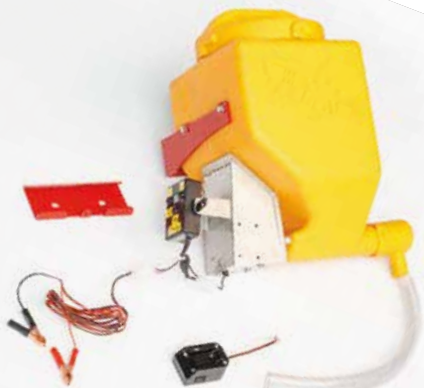

**One controller fits all!
Now available with
DeWalt or Milwaukee
18 Volt Adaptors**

Your inoculant will be augered out which eliminates clogging!
Comes with mounting brackets and wiring. For use on balers, choppers, seeders, planters, baggers and more!



PRICES SUBJECT TO CHANGE WITHOUT NOTICE

NH AFTERMARKET CHOPPER TABLES AND ACCESSORIES

New Holland® is a Registered Trademark of CNH Industrial America LLC which does not manufacture or endorse these parts.

PART NUMBER	DESCRIPTION	PRICE
JM80400	717-718 6' Harvester Table Complete NEW!	\$1400.00
JM80401	717-718 8' Harvester Table Complete NEW!	\$1575.00
JM80402	782-790 Harvester Table Complete NEW!	\$1575.00
JM80403	890-892 Harvester Table Complete NEW!	\$1890.00
JM80404	900 Harvester Table Complete NEW!	\$1990.00
JM80405	717-718 6' Table Belt NEW! 16"x138 ⁵ / ₈ " with Pin	\$236.07
JM80406	717-718-782-790 NEW! 8' Table Belt 16"x195 ¹ / ₂ " with Pin	\$296.23
JM80407	890-892-900 NEW! Table Belt 18"x195 ¹ / ₂ " with Pin	\$319.00



All chopper tables are complete to linkage on safety lever



We custom make chopper table belts 16", 18", and 20"

JM80408	Back Table Roller 1 ¹ / ₄ " Shaft NEW!	\$136.93	
JM80409	Front Table Roller 1" Shaft NEW!	\$125.84	
JM80410	Back Table Roller Bearing 1 ¹ / ₄ " 2 pcs. per roller NEW!	\$11.71	
JM80411	Front Table Roller Bearing 1" 2 pcs. per roller NEW!	\$13.32	

PRICES SUBJECT TO CHANGE WITHOUT NOTICE

717.464.1043

AFTERMARKET TABLE SPROCKETS AND ADAPTORS

PART NUMBER	DESCRIPTION	PRICE		
JM80412	717-718 Sprocket to Drive Table on B.F. Feedroll NEW! Welding required 50x17 with machined shaft collar to fit over 50x30 sprocket	\$38.68		
JM80413	717-718 Table Roller 50x34 Sprocket NEW!	\$52.60		
JM80414	782-790 Sprocket to Drive Table on B.F. Feedroll NEW! 50x25 Welding required	\$30.89		
JM80415	782-790 Table Roller NEW! 50x36, 50x20 Double Sprocket	\$72.67		
JM80416	890-892 Sprocket Kit NEW! to bolt on B.F. Feedroll 60x24T. 60x11T. Welding required	\$62.70		
JM80417	890-892-900 Table Roller NEW! 60x20, 60x30	\$62.70		
JM80418	890-892 Triple Sprocket for B.F. Feedroll 1 1/4" Shaft NEW! 50x30T. 60x24T. 60x11T.	\$95.14		

PRICES SUBJECT TO CHANGE WITHOUT NOTICE

NH 900 >> AFTERMARKET REPLACEMENT HARVESTER PARTS













New Holland® is a Registered Trademark of CNH Industrial America LLC which does not manufacture or endorse these parts.

PART NUMBER	DESCRIPTION	PRICE		
JM12124	Ball Bearing on Front at PTO	\$42.25	 JM12124	 JM9847177
JM9847177	Front PTO Bearing (after serial #909055)	\$82.00		
JM122956	Auger Sprocket Bushing	\$14.80		
JM136684	Special Turner Nut (BSN 767916)	\$30.98		
JM136801	Stake Nut on cutterhead shaft	\$38.04		
JM136909	Special Feedroll Washer on top feedrolls	\$13.80		
JM165584	Head Lift Roller with Bushing	\$223.05		
JM165585	Bushing	\$34.79		
JM224355	Clutch Disc (sharpener)	\$25.25		
JM225387	900 Blower Band Wear Plate (stainless steel) Comes with bolts	\$126.50	 JM225387	 JM225396
JM225396	900 Blower Band	\$224.28		
JM225678	Cutterhead Sprocket (16 tooth) For auger chain	\$118.29		
JM225679	Auger Sprocket with Bushing	\$75.42		
JM226196	Cutterhead PTO Pin	\$41.66		
JM237805	Spacer on head lift roller	\$13.80		
JM243465	#50 USA Auger Chain 123 Pitches	\$94.33		
JM271689	Shims on Blower (as required)	\$0.93		

PRICES SUBJECT TO CHANGE WITHOUT NOTICE

717.464.1043

NH 900 » AFTERMARKET REPLACEMENT HARVESTER PARTS

PART NUMBER	DESCRIPTION	PRICE		
JM27696	Washer in Cutterhead Shear Pin Yoke	\$3.48		
JM27767	Sharpener Spline Bushing	\$9.01		
JM280656	Fan Paddle Bolt with nut, flat, and lock washer	\$5.55 per piece		
JM280700	Set of 6	\$33.30 per set of 6		
JM280732	900 Knife Bolt 5/8 x 1 1/2 Gr. 8 FT	\$0.93		
JM285072	5/16 Hardened Washer For blower slip disc	\$1.77		
JM37185	Snap Ring (used on front PTO yoke)	\$14.73		
JM40974	Snap Ring in Cutterhead Shear Pin Yoke	\$4.53		
JM43090015	900 Operator's Manual	\$47.79		
JM45440	Snap Ring on Blower	\$9.18		
JM46520	Shear Pin (Pkg of 10)	\$6.10		
JM528526	Bushing in Cutterhead Shear Pin Yoke	\$9.00		
JM56704	Bushing For 900 tongue pin (Subs to #84605014)	\$62.60		
JM600486	Sharpener Rail	\$175.47		
JM600488	Sharpener Handle	\$18.35		
JM601109	900 Side Plate Bushing	\$4.66		

PRICES SUBJECT TO CHANGE WITHOUT NOTICE

PART NUMBER	DESCRIPTION	PRICE		
JM614082	Cap on 900 Angle Gearbox	\$283.63		
JM614084	Front Angle Gearbox Cover Subs to #86636033	\$240.90		
JM615546	USA60 Chain (48 pitches) (for upper feedroll)	\$52.59		
JM619208	Front Bearing Housing (same as 892)	\$113.33		
JM632649	Angle Gearbox <u>Rebuilt</u>	Call for Price		
JM633389	12-19 Tooth Length of Cut Sprocket	\$156.77		
JM633395	38 Tooth Top Drive Metal-Alert Sprocket	\$198.26		
JM636324	900 Cutter Head	\$1891.97		
JM636475	900 Knife Block	\$89.06	<i>We have used ones for \$25.00</i>	
JM636777	Auger Trough Wear Liner on Cutterhead End	\$63.83		
JM636777A	Auger Trough	\$182.00		

PRICES SUBJECT TO CHANGE WITHOUT NOTICE

717.464.1043

NH 900 >> AFTERMARKET REPLACEMENT HARVESTER PARTS

PART NUMBER	DESCRIPTION	PRICE		
JM637464	900 Auger Sheet Against Blower	\$162.34		
JM637465	Front Auger Sheet	\$93.44		
JM637895	Knob for 900 Shields O.E.M.	\$382.06		
JM639108	Head Drive Sprocket	\$103.60		
JM639338	Upper Rear Feedroll For 900 and FP230 Always order for each end 1 pc. JM136909 step washer	\$424.14		
JM639349	900 Smooth Roll Always order 2 pc. JM38766 bearing insert	\$248.02		
JM639766	Bracket on 900 Drive Line NEW!	\$98.00		
JM639787	Front PTO Support	\$89.50		
JM640220	Short 900 PTO Shaft For short tongue	\$499.96		
JM640291	Screw for 900 PTO Yoke	\$10.07		
JM641630	Non-Metal-Alert Bottom Front Feedroll	\$469.68		

PRICES SUBJECT TO CHANGE WITHOUT NOTICE

PART NUMBER	DESCRIPTION	PRICE		
JM641777	900 Feedroll Arm with Bushing Included	\$83.51		
JM642360	Support with 3 Holes at Feedroll Side Plate	\$14.20		
JM642366	Sharpener Cover	\$64.34		
JM642371	Smooth Roll Scraper	\$154.68		
JM676997	900 Knife	\$81.00		
JM677563	900 Female Plug - Harvester End	\$120.63	 900 Female Plug	 900 Male Plug
JM762836	900 Male Plug - Control Box End	\$101.91		
JM676900	Cutter Head Bottom 900 NEW!	\$69.67		
JM686583	Lock Out Plate	\$32.93		
JM678615	Friction Spacer On 900 blower	\$7.47		
JM678617	Friction Disc On 900 blower	\$334.95		
JM678619	Spring Washer on Blower	\$1.46		
JM678621	Outer Blower Slip Disc Plate	\$307.03		
JM678626	Input Angle Gearbox Shaft (bearings & seals available) For 900 Only	\$884.81		

PRICES SUBJECT TO CHANGE WITHOUT NOTICE

717.464.1043

PART NUMBER	DESCRIPTION	PRICE		
JM678912	Rear Blower Sheet (used before Serial # 78114)	\$195.00		
JM682360	Feedroll Power Switch	\$114.00	 JM682360	 JM682361
JM682361	Feedroll Rocker Switch	\$113.00		
JM688963	Smooth Roll Sprocket	\$102.70		
JM690222	Sharpener Spline Stub	\$50.34		
JM690225	Sharpener Spline Only	\$141.25		
JM690226	Cutterhead Shaft with Shear Pin Plate	\$168.06		
JM697394	Stake Nut on Blower	\$161.25		
JM697395	Sleeve 900 Blower NEW!	\$12.00		
JM697396	Cover on 900 Blower	\$60.05		
JM697397	Star Plate on Blower Fan	\$289.68		
JM705279	Bearing Collar on Cutterhead (special plastic)	\$38.48		
JM714504	Sprocket Yoke on Rear Feedroll	\$291.76		

PRICES SUBJECT TO CHANGE WITHOUT NOTICE

PART NUMBER	DESCRIPTION	PRICE	
JM715357	900 Feedroll Pad	\$15.80	
JM762790	Spline Hub (on 900 blower at rear)	\$110.33	
JM768235	Stone Holder	\$101.01	
JM768236	Stone Holder Cap (for 900 and 790 only)	\$111.30	
JM771820	Short Auger Lid Baffle They are the same on long and short auger	\$90.63	
JM791531	Auger Lid Hinges	\$7.10	
JM796353	Yoke and Tube to Cutterhead Yoke	\$375.55	
JM80138243	Gooseneck Turner Nut Pin	\$24.48	
JM803348	Hinge on Cover	\$43.60	
JM851697	790-900 Clamp Washer	\$17.20	
JM851709	Shear Bar Adjuster Rod (after serial # 751185) Also fits FP230-240	\$35.81	
JM853616	Sharpener Carrier with Bushings with Roller	\$241.54	
JM9803718	Cam Bearing For on Bottom of Carrier	\$23.35	
JM854381	Gooseneck Turner Nut (ASN 767917)	\$38.48	

PRICES SUBJECT TO CHANGE WITHOUT NOTICE

717.464.1043

PART NUMBER	DESCRIPTION	PRICE	
JM859106	Cutterhead Sprocket (19 tooth standard)	\$101.20	
JM86511977	5/16 x 3/4 Oval Head Bolt with Flange Nut (for on wear plate) Takes 6 bolts per wear plate	\$0.85 each	
JM86514713	Spline Coupler In front of gearbox	\$125.22	
JM86514714	Spline Shaft In front of angle gearbox	\$183.26	
JM86517158	Bracket on Cutterhead PTO	\$43.08	
JM86517279	Transition with Tube on Top (Specify) BSN 781114	\$605.00	
JM86521513	Square Coupler	\$74.00	
JM86528652	900 Knife Bolt Washer	\$1.80	
JM86598202	Transition with Flat Top Also used on 230-240	\$686.82	
JM86620027	1 1/2 Bearing Flanges (4 pieces for short tongue for on long PTO shaft)	\$6.91	
JM86620779	Steel Spout Deflector	\$59.46	
JM86622143	Steel Spout Deflector Spring	\$8.73	
JM86622174	Steel Spout Deflector Bracket	\$16.56	

PRICES SUBJECT TO CHANGE WITHOUT NOTICE

PART NUMBER	DESCRIPTION	PRICE		
JM86635517	Spindle for Wheel	\$203.87		
JM86635853	J – Bolt (for on blower band)	\$19.29		
JM86635877	26-30 Tooth Length of Cut Sprocket	\$156.34		
JM86613003A	28-32 Tooth Length of Cut Sprocket	\$163.00		
JM86635888	RH Bearing Support with Races #JM36723T takes 2pc. JM36726T and 2 pc. JM48198 bearings (billed separately)	\$248.26		JM86635888
JM86635889	LH Bearing Support with Races #JM36723T takes 4pc. JM48198 bearings	\$226.04		
JM86635892	LH Crop Guide with Bolts	\$46.00		
JM86635893	RH Crop Guide with bolts	\$46.00		
JM86635908	Feedroll Spring Nut	\$38.72		
JM86635909	Used spring with new insert	\$112.56		
JM86635911	Smooth Roll Bearing Housing Only	\$87.00		
JM8663591	SA206FP9 Insert Only	\$28.14		
JM9000	Hydraulic Tongue Swing Kit	\$1513.20		
JM595512	Swing Kit Cylinder	\$800.00		
JM9609162	Cylinder Kit Bracket Only	\$424.00		
JM86636511	Wing Nut	\$12.59		

PRICES SUBJECT TO CHANGE WITHOUT NOTICE







PART NUMBER	DESCRIPTION	PRICE	
JM86636978	Front Blower Plate	\$258.19	
JM86641950	900 Knife Baffle	\$19.18	
JM88635	Slotted Nut On Shear Bar Adj. Rod For 790-900-FP230-FP240	\$6.64	
JM88864	5/16 x 2" Gr. 8 CT Bolt (for on blower) Pk. of 9	\$10.49 Pkg. of 9	
JM9065	Support Pole Complete	\$617.50	
JM9601646	Paddle Arm	\$35.74	
JM9609440	Bushing on Feedroll Baffle BSN 875828	\$6.81	
JM9609478	900 Auger Lid – 84" (Short) Comes with Hinges (Old Style) Used BSN 767916	\$220.00	
JM9609485	Auger for 900 Short auger for 76" BSN 781114	\$592.72	
JM9806283	Auger for 900 Long auger for 81" ASN 781115	\$592.87	
JM9610638	Cupped Fan Paddle for 900	\$130.43 Per Set of 3	
JM9611168	Shear Bar (ASN 751185, with holes)	\$332.48	

PRICES SUBJECT TO CHANGE WITHOUT NOTICE

PART NUMBER	DESCRIPTION	PRICE		
JM9617273	Shear Bar Adjuster Rod (BSN 751184)	\$34.52		
JM9614489	Long Auger Lid Baffle They are the same on long and short auger	\$125.04		
JM9614491	Rear Blower Sheet (ASN 781115)	\$247.62		
JM9616873	Cone Washer on Shear Bar Adjuster	\$9.86		
JM9616875	Cone Washer on Shear Bar Adjuster	\$9.86		
JM9617027	900 Auger Lid – 88" Long, w/Hinges (New Style) Used ASN 767917	\$238.50		
JM9617281	900 Shear Bar Adjuster Insert BSN 751184 Use JM9623519 ASN 751185	\$23.32		
JM9617519	Shear Bar (BSN 751184, no holes)	\$319.28		
JM9618047	Yoke and Gear Also fits 890-892 Takes JM200-2600 Cross & Bearing Kit	\$648.00		
JM9619871	Sharpener Stone Comes packaged with 4 O-rings	\$58.60		
JM9623846	Spline Shaft for Head Drive	\$127.72		
JM9820509	Friction Washer On Shear Bar Adj. Rod For 900-FP230-FP240	\$9.25		

PRICES SUBJECT TO CHANGE WITHOUT NOTICE

NH 900 >> AFTERMARKET REPLACEMENT HARVESTER PARTS

PART NUMBER	DESCRIPTION	PRICE		
JM9827836	Kicker Bracket on Sharpener	\$79.16		
JM9842620	LH Side Plate	\$143.52	LH 	RH 
JM9843091	RH Side Plate	\$143.52	 JM9842620	 JM9843091
JM9842999	Long 900 PTO Shaft (for long tongue)	\$536.50		
JM642361	Bottom Roll Bearing Holder NEW!	\$19.02		
JM854233	Chain Beside Gearbox	\$80.69	[PHOTO NOT AVAILABLE]	

NH 900 BEARINGS, RACES, OIL SEALS

For Prices go to Bearings Pages

900 ANGLE GEAR BOX

Timken	New Holland	Qty.	Description
JM3780	174127	1	Bearing
JM3720	174125	1	Race
JM472439	612675	1	Seal
JM25577	511644	1	Bearing
JM25520	13958	1	Race
JM473231	137547	1	Seal
JM N/A	767618	2	Seal
JM N/A	86536196	1	Bearing & Race
JM104911	287066	1	Race
JM104948	199954	1	Bearing

900 REVERSING GEAR BOX

Timken	New Holland	Qty.	Description
JM352541	181991	5	Seal
JMLM104911	287066	5	Race
JMLM104949	287902	5	Bearing
JM474278	136771	1	Seal
JMLM29749	1996	1	Bearing
JMLM29710	1995	1	Race
JMNTA2031	633285	1	Thr. Bearing
JM410163	701519	1	Seal
JMLM67010	36723	1	Race
JMLM67048	36726	1	Bearing
JM44643	132710	1	Bearing
JM44610	132709	1	Race
JM472439	612675	1	Seal

PRICES SUBJECT TO CHANGE WITHOUT NOTICE





NH FP230 & FP240 » AFTERMARKET REPLACEMENT HARVESTER PARTS

New Holland® is a Registered Trademark of CNH Industrial America LLC which does not manufacture or endorse these parts.

PART NUMBER	DESCRIPTION	PRICE	
JM225387	Wear Liner, Stainless Steel (Same as 892) Comes with bolts!	\$126.50	
JM47618652	Friction Disc for Blower (Same as part #127434 and #65049)	\$55.87	<i>Also fits most NH hay heads!</i> 
JM636475	Knife Block on FP230 and FP240	\$89.06	<i>We have used ones for \$25.00</i> 
JM639338	FP230 Upper Rear Feedroll Also fits 900	\$424.14	
JM639349	FP230 Smooth Roll (same as 900) Always order 2pc. JM38766 bearing insert.	\$248.02	
JM641777	Feedroll Arm with Bushing	\$83.51	
JM642371	FP230 Smooth Roll Scraper (same as 900)	\$154.68	
JM676230	Cutterhead Bottom FP230 NEW!	\$60.81	
JM676240	Cutterhead Bottom FP240 NEW!	\$64.32	
JM676997	NHFP230 Knife (Same as 900)	\$81.00	
JM714504	Sprocket, Yoke on Rear Feedroll	\$291.76	
JM8098	Operator's Manual FP230-FP240	\$58.62	
JM851709	Shear Bar Adjuster Rod (after serial # 751185) Also fits FP230-240	\$35.81	

PRICES SUBJECT TO CHANGE WITHOUT NOTICE

717.464.1043

PART NUMBER	DESCRIPTION	PRICE	
JM86512516	FP240 Smooth Roll Always order 2pc. JM38766 bearing insert	\$298.11	
JM86547234	Input Gearbox Shaft For FP230-FP240 only	\$715.00	
JM86551519	Rear PTO Implement Yoke with Taper Spline Fits only 55 Series	\$297.85	
JM86559854	Hydraulic Tongue Swing Kit FP230-240	\$1513.20	
JM87018102	Hydraulic Tongue Cylinder FP230-240 This cylinder ear is larger than for the 900, otherwise the kit is the same.	\$800.00	
JM86575566	FP240 Cutterhead PTO Shaft with Shear Pin	\$168.06	
JM86598202	Transition with Flat Top Fits all FP230-FP240 Also used on 900	\$686.82	
JM86615412	Fan Paddle, Cupped (for all 3 paddle blowers)	\$140.50 Per Set of 3	
JM86618727	FP230-FP240 Auger Uses 2pc. JM38766 bearing insert	\$595.00	
JM86624446	NHFP240 Knife	\$115.14	
JM86627930	FP230-FP240 Auger Lid Comes with hinges on	\$166.48	
JM86632157	FP 240 Shear Bar Original OEM with aftermarket replacement price!	\$342.00	
JM86632788	FP230 Shear Bar Original OEM with aftermarket replacement price!	\$312.00	



PRICES SUBJECT TO CHANGE WITHOUT NOTICE

PART NUMBER	DESCRIPTION	PRICE		
JM86635000	Bottom Front Feedroll – Non Metal-Alert (FP240 only)	\$510.47		
JM86635892	LH Crop Guide with Bolts	\$46.00		
JM86635893	RH Crop Guide with bolts	\$46.00		
JM86635935	FP240 Upper Feedroll	\$444.44		
JM86635936	FP240 Smooth Roll Scraper	\$156.20		
JM86635888	RH Bearing Support (same as 900) With races JM36723T Takes 2pc. JM36726T and 2pc. JM48198 bearings	\$248.26		
JM86635889	LH Bearing Support (same as 900) With races JM36723T Takes 4pc. JM48198 bearings	\$226.04		
JM86635943	LH Side Plate	\$143.52		
JM86635945	RH Side Plate	\$143.52		
JM86635950	FP240 Knife Baffle	\$23.74		
JM86636606	Fan Paddle, Cupped (for all 4 paddle blowers)	\$187.33 Per Set of 4		
JM86636614	Blower Band (same as 892)	\$224.28		

PRICES SUBJECT TO CHANGE WITHOUT NOTICE







717.464.1043

NH FP230 & FP240 >> AFTERMARKET REPLACEMENT HARVESTER PARTS

PART NUMBER	DESCRIPTION	PRICE	
JM86637313	FP230-FP240 Rear Blower Panel	\$233.32	
JM9060	FP230-FP240 Support Pole Complete	\$641.25	
JM9805207	FP230-FP240 Sharpening Stone Comes packaged with 4 O-rings.	\$68.00	





NH HARVESTER AFTERMARKET REPLACEMENT GOOSENECKS & PARTS

New Holland® is a Registered Trademark of CNH Industrial America LLC which does not manufacture or endorse these parts.

PART NUMBER	DESCRIPTION	PRICE		
JM268339	Upright Extension 15" For 782, 790, 892, 900	\$169.72		JM268339
	<i>Only Fits Choppers with Flat Steel Hold Downs</i> 20"	\$204.24		
	24"	\$231.95		
	<i>Only While Supplies Last</i> 32"	\$286.80		
JM269975	Spout Liner, Stainless Steel Comes with bolts!	\$228.70	<i>Fits All Adjustable Goosenecks!</i>	
JM269975B	Bolt Kit	\$8.40		
JM858834	Cast Iron Gooseneck Holddown	Call for Price		
JM86510024	Cast Iron Gooseneck Holddown	Call for Price		
JM86548300	Bottom Part of Spout Stainless Steel	\$518.00		
JM80906	Regular Steel	\$342.25		
JM86620779	Top Deflector Stainless Steel	\$82.00		
JM80908	Regular Steel	\$49.95		Bottom Part of Spout JM86620781
JM86620781	Adjustable Stainless Steel Spout (complete) With Stainless Steel Wear Liner	\$1,850.00		
JM80910	<i>Specify Stainless Steel or Regular</i> Adjustable Regular Steel Spout (complete) With Stainless Steel Wear Liner	\$1,450.00		

PRICES SUBJECT TO CHANGE WITHOUT NOTICE

NH HARVESTER AFTERMARKET REPLACEMENT GOOSENECKS & PARTS

PART NUMBER	DESCRIPTION	PRICE	
JM86621454	Round Clean Out Cover	\$10.62	
JM86621455	Oval Shape Clean Out Cover	\$10.64	
JM9001	3 Ft. Gooseneck Extension	\$160.34	
JM9002	4 Ft. Gooseneck Extension	\$182.54	
JM9002a	6 Ft. Gooseneck Extension <i>Curved for better flow!</i>	\$241.96	
JM9090	Upright Extension with Thick Flange (To fit cast flange holddowns) For heavy-duty on 790, 900, FP230, FP240	\$295.17	 JM9090
	<i>We Use Heavy Wall Dom Pipe!</i> 15"	\$355.20	
	20"	\$403.39	
	24"	\$498.00	

EQUIPMENT AND SAFETY DECALS

PART NUMBER	DESCRIPTION	PRICE	
JM80800	New Holland Decal NEW! 1¾"H x 16¼"L	\$11.90	
JM80801	New Holland Decal NEW! 2½"H x 24¼"L	\$12.70	
JM80802	New Holland Decal NEW! 3"H x 29"L	\$14.50	

PRICES SUBJECT TO CHANGE WITHOUT NOTICE

717.464.1043

EQUIPMENT AND SAFETY DECALS

PART NUMBER	DESCRIPTION	PRICE	
JM80803	Danger Decal NEW! 2"H x 4"L	\$8.60	 DANGER Moving parts can crush and cut. Keep hands clear. Lockout/tagout before servicing.
JM80804	Warning Decal NEW! 3.5"H x 7"L	\$8.60	 WARNING • Moving parts can crush and cut. • Keep hands clear. • Do not operate with guard removed.
JM80805	Danger Decal NEW! 2"H x 5"L	\$8.60	 DANGER Moving parts can crush and cut. Keep hands clear. Lockout/tagout before servicing.
JM80806	Danger Decal NEW! 7"H x 10"L	\$8.60	 DANGER AMPUTATION HAZARD. Rotating auger and agitators. Keep hands and body clear of hopper. Stop machine and turn power switch to OFF before clearing, oiling or repairing this equipment.
JM80807	Danger Decal NEW! 3½"H x 7"L	\$8.60	 DANGER Climbing, sitting walking or riding on conveyor at any time will cause severe injury or death. KEEP OFF.
JM80808	Joe's Chopper Decal NEW! 2½"H x 16"L	\$8.10	 CHOPPER
JM80809	Joe's Bale Spear NEW! 1½"H x 10"L	\$6.85	 BALE SPEAR
JM80810	Joe's Finger Planter NEW! 1½"H x 14"L	\$7.05	 FINGER PLANTER
JM80811	Joe's Tandem Hitch NEW! 3"H x 24"L	\$14.62	 TANDEM HITCH
JM80812	Joe's Machinery Decal NEW! 2.5"H x 5½"L	\$7.00	
JM80813	824 Decal NEW! 2½"H x 5"L	\$8.40	824
JM80814	990W Decal NEW! 2½"H x 5"L	\$8.40	990W
JM80815	27P Decal NEW! 2⅝"H x 4¾"L	\$8.40	27P

PRICES SUBJECT TO CHANGE WITHOUT NOTICE

PART NUMBER	DESCRIPTION	PRICE
JM80816	Mower Decal NEW! 2½"H x 5"L	\$8.40
JM80817	Crimper Decal NEW! 2½"H x 5"L	\$8.40
JM80818	Rake Decal NEW! 2½"H x 4¾"L	\$8.40
JM80819	Rake Decal NEW! 2½"H x 5"L	\$8.40
JM80820	Rake Decal NEW! 2½"H x 5"L	\$8.40
JM80821	Chopper Decal NEW! 3"H x 4¾"L	\$8.40
JM80822	Chopper Decal NEW! 3"H x 6¾"L	\$8.40
JM80823	Chopper Decal NEW! 3"H x 5"L	\$8.40
JM80824	Chopper Decal NEW! 3"H x 6"L	\$8.40
JM80825	Chopper Decal NEW! 2½"H x 5"L	\$8.40
JM80826	Chopper Decal NEW! 3¼"H x 6"L	\$8.40
JM80827	Chopper Decal NEW! 2½"H x 5"L	\$8.40
JM80828	Chopper Decal NEW! 2¾"H x 5"L	\$8.40
JM80829	Chopper Decal NEW! 3"H x 9½"L	\$8.40
JM80830	29P Decal NEW! 2⅝"H x 5"L	\$8.40

PRICES SUBJECT TO CHANGE WITHOUT NOTICE

717.464.1043

USA CONNECTOR LINKS

PART NUMBER	OLD PART NUMBER	CHAIN SIZE	BOX PART NUMBER	QTY. PER BOX	PRICE
DR35-CL	RC35CLUS	35-1R	DR35-CL-BX	25	\$1.95
DR40-CL	RC40CLUS	40-1R	DR40-CL-BX	25	\$1.95
DR40-2-CL	RC402CLUS	40-2R	DR40-2-CL-BX	25	\$3.60
DR41-CL	RC41CLUS	41-1R	DR41-CL-BX	25	\$1.95
DR50-CL	RC50CLUS	50-1R	DR50-CL-BX	25	\$2.25
DR50-2-CL	RC502CLUS	50-2R	DR50-2-CL-BX	25	\$3.80
DR60-CL	RC60CLUS	60-1R	DR60-CL-BX	25	\$4.10
DR60-2-CL	RC602CLUS	60-2R	DR60-2-CL-BX	25	\$5.95
DR60H-CL	RC60HCLUS	60H-1R	DR60H-CL-BX	25	\$5.20
DR80-CL	RC80CLUS	80-1R	DR80-CL-BX	15	\$5.40
DR80-2-CL	RC802CLUS	80-2R	DR80-2-CL-BX	15	\$9.90
DR80H-CL	RC80HCLUS	80H-1R	DR80H-CL-BX	15	\$7.65
DR100-CL	RC100CLUS	100-1R	DR100-CL-BX	10	\$8.30
DR100H-CL	RC100HCLUS	100H-1R	DR100H-CL-BX	10	\$10.70
DR120-CL	RC120CLUS	120-1R	DR120-CL-BX	10	\$10.10
DR120H-CL	RC120HCLUS	120H-1R	DR120H-CL-BX	10	\$13.95
DR140-CL	RC140CLUS	140-1R	DR140-CL-BX	10	\$15.00
DR160-CL	RC160CLUS	160-1R	DR160-CL-BX	10	\$21.15
DR160H-CL	RC160HCLUS	160H-1R	DR160H-CL-BX	10	\$27.15
DRA2040-CL	RCA2040CLUS	A2040	DRA2040-CL-BX	25	\$2.30
DRA2050-CL	RCA2050CLUS	A2050	DRA2050-CL-BX	25	\$3.35
DRA2060-CL	RCA2060CLUS	A2060	DRA2060-CL-BX	25	\$3.45
DRA2080H-CL	RCA2080HCLUS	C2080H	DRC2080H-CL-BX	15	\$10.50
DRCA550-CL	RCCA550CLUS	CA550	DRCA550-CL-BX	15	\$5.50
DRCA620-CL	RCCA620CLUS	CA620	DRCA620-CL-BX	20	\$6.25

USA OFFSET LINKS

PART NUMBER	OLD PART NUMBER	CHAIN SIZE	BOX PART NUMBER	QTY. PER BOX	PRICE
DR35-HL	RC35HLUS	35-1R	DR35-HL-BX	25	\$3.35
DR40-HL	RC40HLUS	40-1R	DR40-HL-BX	25	\$4.30
DR40-2-HL	RC402HLUS	40-2R	DR40-2-HL-BX	25	\$9.40
DR41-HL	RC41HLUS	41-1R	DR41-HL-BX	25	\$6.05
DR50-HL	RC50HLUS	50-1R	DR50-HL-BX	25	\$4.20
DR50-2-HL	RC502HLUS	50-2R	DR50-2-HL-BX	25	\$11.00
DR60-HL	RC60HLUS	60-1R	DR60-HL-BX	25	\$5.35
DR60-2-HL	RC602HLUS	60-2R	DR60-2-HL-BX	25	\$12.30
DR60H-HL	RC60HHLUS	60H-1R	DR60H-HL-BX	25	\$7.20
DR80-HL	RC80HLUS	80-1R	DR80-HL-BX	15	\$12.30
DR80-2HL	RC802HLUS	80-2R	DR80-2-HL-BX	15	\$26.15
DR80H-HL	RC80HHLUS	80H-1R	DR80H-HL-BX	15	\$15.75
DR100-HL	RC100HLUS	100-1R	DR100-HL-BX	10	\$18.40
DR100H-HL	RC100HLUS	100H-1R	DR100H-HL-BX	10	\$21.80
DR120-HL	RC120HLUS	120-1R	DR120-HL-BX	10	\$28.40
DR120H-HL	RC120HHLUS	120H-1R	DR120H-HL-BX	10	\$30.55
DR140HL	RC140HLUS	140-1R	DR140-HL-BX	10	\$31.45
DR160HL	RC160HLUS	160-1R	DR160-HL-BX	10	\$40.30
DR160H-HL	RC160HHLUS	160H-1R	DR160H-HL-BX	10	\$63.60
DRA2040-HL	RCA2040HLUS	A2040	DRA2040-HL-BX	25	\$4.15
DRA2050-HL	RCA2050HLUS	A2050	DRA2050-HL-BX	25	\$4.85
DRA2060-HL	RCA2060HLUS	A2060	DRA2060-HL-BX	25	\$6.35
DRA2080H-HL	RCCA2080HHLUS	C2080H	DRA2080H-HL-BX	15	\$17.50
DRCA550-HL	RCCA550HLUS	CA550	DRCA550-HL-BX	15	\$5.50

PRICES SUBJECT TO CHANGE WITHOUT NOTICE

TIMKEN

Where You Turn



TIMKEN DRIVES USA ROLLER CHAIN

PART NUMBER	OLD PART NUMBER	CHAIN SIZE	PITCH	PACKAGE TYPE	PRICE
DR3510	RC35US	35-1	3/8"	10ft. / box	\$72.70
DR40-10	RC40US	40-1R	1/2"	10ft. / box	\$58.20
DR40-50	RC40USR	40-1R	1/2"	50ft. / reel	\$290.95
DR40-2-10	RC402US	40-2R	1/2"	10ft. / box	\$192.45
DR41-10	RC41US	41-1R	1/2"	10ft. / box	\$68.05
DR41-50	RC41USR	41-1R	1/2"	50 ft. / reel	\$335.25
DR50-10	RC50US	50-1R	5/8"	10ft. / box	\$71.40
DR50-50	RC50UR	50-1R	5/8"	50 ft. / reel	\$357.00
DR50-2-10	RC502US	50-2R	5/8"	10 ft. / box	\$214.45
DR60-10	RC60US	60-1R	3/4"	10 ft. / box	\$90.60
DR60-50	RC60URS	60-1R	3/4"	50 ft. / reel	\$453.20
DR60-2-10	RC602US	60-2R	3/4"	10 ft. / box	\$314.40
DR60-2-50	RC602USR	60-2R	3/4"	50 ft. / reel	\$1571.72
DR60H-10	RC60HUS	60H-1R	3/4"	10 ft. / box	\$130.70
DR60H-50	RC60HUSR	60H-1R	3/4"	50 ft. / reel	\$653.40
DR80-10	RC80US	80-1R	1"	10 ft. / box	\$179.50
DR80-50	RC80USR	80-1R	1"	50 ft. / reel	\$897.55
DR80-2-10	RC802US	80-2R	1"	10 ft. / box	\$578.80
DR80H-10	RC80HUS	80H-1R	1"	10 ft. / box	\$265.35
DR80H-50	RC80HUSR	80H-1R	1"	50 ft. / reel	\$1380.05
DR100-10	RC100US	100-1R	1 1/4"	10 ft. / box	\$310.40
DR100H-10	RC100HUS	100H-1R	1 1/4"	10 ft. / box	\$412.45
DR120-10	RC120US	120-1R	1 1/2"	10 ft. / box	\$463.80
DR120H-10	RC12HUS	120H-1R	1 1/2"	10 ft. / box	\$530.45
DR140-10	RC140US	140-1R	1 3/4"	10 ft. / box	\$598.25
DR160-10	RC160S	160-1R	2"	10 ft. / box	\$732.35
DR160H-10	RC160HUS	160H-1R	2"	10 ft. / box	\$941.10
DRA2040-10	RCA2040US	A2040	1"	10 ft. / box	\$82.60
DRA2040-50	RCA2040USR	A2040	1"	50 ft. / reel	\$413.10
DRA2050-10	RCA2050US	A2050	1 1/4"	10 ft. / box	\$59.60
DRA2050-50	RCA2050USR	A2050	1 1/4"	50 ft. / reel	\$298.30
DRA2060-10	RCA2060US	A2060	1 1/2"	10 ft. / box	\$134.15
DRA2060-50	RCA2060USR	A2060	1 1/2"	50 ft. / reel	\$670.70
DRCA550-10	RCCA550US	CA550	1.63"	10 ft. / box	\$127.55
DRCA550-50	RCCA550USR	CA550	1.63"	50 ft. / reel	\$632.25

*We sell USA chain, sprockets, idler sprockets, pulleys, pulley bushings, belts, grease, and oil!
We sell oil in bulk or 5 gallon buckets — 15W40, AW46 hydraulic oil and tractor hydraulic oil.*

PRICES SUBJECT TO CHANGE WITHOUT NOTICE

717.464.1043

SCREAM SCREENS!

We always need three measurements
or your machine model.

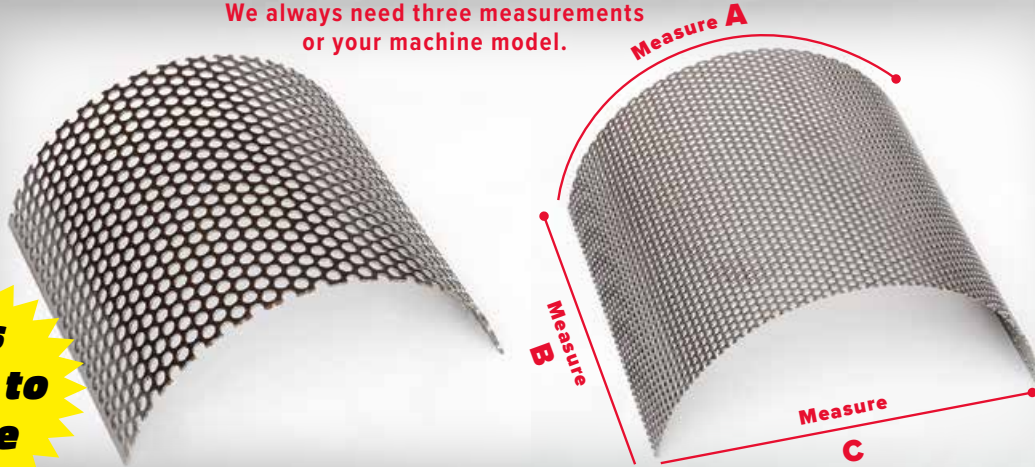

**Prices
Subject to
Change**

DESCRIPTION	PRICE
JM9003 Gehl 95, 100, 115, 120, 125, 135, 170 Same size fits all / We stock sizes 1/8" to 1"	\$295.00
JM9004 New Holland 351, 352, 353, 354 Same size fits all / We stock sizes 1/8" to 5/8" Same as Farmhand 315-812-817	\$245.00
JM9005 New Holland 355, 358 Same size fits both / We stock sizes 1/8" to 5/8"	\$265.00
JM9006 Owatonna We stock sizes 1/4" to 1/2"	Call for price
JM9007 John Deere We stock sizes 3/16" to 5/8"	Call for price
JM9008 Massey Ferguson We stock sizes 5/16", 3/8", 1/2"	Call for price
JM9009 International 1350 We stock sizes 1/4" to 1/4"	\$387.75
JM9010 International 1150 We stock sizes 1/4" to 1/2"	\$295.00

Farmhand and New Holland screens are same if width is 16"

Non stock screens can be ordered in ANY SIZE!

For odd sizes, there is a 2 piece minimum order for us to manufacture them.

International, Papec, Antsaway, & Massey Ferguson screens are same if width is 19 3/4"



717. 464 .1043 » 259 Radcliff Rd. » Willow Street, PA 17584

New Holland® is a Registered Trademark of CNH Industrial America LLC which does not manufacture or endorse these parts.

PART NUMBER	DESCRIPTION	PRICE	
BEARING INSERTS			
JM9011	FYH Bearing Insert - SA205-14FP9 Used on (7/8 bore) 717-718-770 smooth rolls on the RH side	\$21.25	
JM9012	FYH Bearing Insert - SA205-16FP9 Used on (1" bore) shafts, etc. Front table rollers, etc.	\$21.71	
JM9013	FYH Bearing Insert - SA206-18FP9 Used on (1 1/8 bore) 782-790-890-892 smooth rolls and bottom front feedrolls and drivers on original models	\$26.38	
JM38766	Bearing Insert - FYH SA206-20FP9 or FP7 Used on 824 cornheads, NH harvester augers, and more	\$26.09	
JM47066	Bearing Insert FYH SA207-22 FP7 Non-greasable (1 3/8 bore) For long PTO shafts on NH harvesters (782-790-890-892)	\$33.46	
JM52443	FYH SA208-24 FP7 Non-Greasable For long PTO on 900 harvesters	\$39.14	
JM225614	Bearing Insert FYH SA209-28 FP9 (1 3/4 bore) Used on several different harvester applications	\$44.81	

We stock FYH and KML bearings in pillow block and inserts. Call with your needs!

Always specify if you need a greasable or non-greasable bearing insert.

FP9 is greasable · FP7 is non-greasable.

SA is for flat on back of bearing · NA is for bearing with lip

FYH bearings don't need much grease.

Most people over grease. Some people never grease. Some people grease all the time.

Our FYH bearings require only 1/2 pump a day or less.

PRICES SUBJECT TO CHANGE WITHOUT NOTICE

717.464.1043

TIMKEN BEARINGS

PART NUMBER	DESCRIPTION	PRICE		
JM121506	Bearing and Race Assembly (same as LM 29710 race and LM 29749 bearing) fits on a lot of chopper wheel assemblies.	\$42.03		
JM132710	Bearing (L44643) Used on 824 corn heads, or 456 crankshaft pin	\$11.75		
JM166258	Timken Bearing Fits on NH 890-892-900, FP 230 & FP240 cutterheads (387A Timken)	\$41.00		
JM199954	Timken Bearing (JLM104948) Used on 717, 718, 770, 782, 790 Harvester cutterheads and some wobble boxes	\$32.06		
JM224556	Timken Bearing Fits into 892 transmission (02876 Timken)	\$62.22		
JM9015	China 25590 Bearing Large bearing on pit spreader (8-lug)	\$8.70		
JM9016	China 25877 Bearing Small bearing on pit spreader (8-lug)	\$7.90		
JM9017	LM29749 Timken Bearing In harvester wheels	\$24.49		
JM36724T	Timken Bearing (LM11949)	\$8.79		
JM36724C	China Bearing (LM11949) Used on Farmbilt 4-lug hub assemblies, (outer) NH mower and crimpers (outer) wheels, on NH 456 mower heads and more	\$3.30		
JM36726T	Timken Bearing (LM67048)	\$10.88		
JM36726C	China Bearing (LM67048) Used on many NH farm equipment applications, hay rake gearboxes and wheel housings, Farmbilt 6-lug hub assembly (outer), also 6-lug Amish built forecarts (outer) or wagons, 824 corn heads, NH harvesters and so much more!	\$3.60		
JM48198	Timken Bearing with Seal (LM67000LA-902A1) Used on 890, 892, 900, FP230, FP240 upper feedroll arms (6 pc.) Used on 824 corn heads and much more!	\$21.19		
JM9014C	China Bearing JL69349 Used on all 6-lug Farmbilt hubs (inner), wagons and carts	\$5.03		
JM9014T	Timken Bearing JL69349	\$22.85		
JM86052	Bearing (LM48500LA) Used in main casting on mower, also on 782 and 790 harvester blower	\$27.13		
JM86512015	Timken Bearing (Timken LM501349) Used in 900 blower star	\$27.15		

PRICES SUBJECT TO CHANGE WITHOUT NOTICE

Timken unless noted otherwise.

PRICES MAY NOT LAST THROUGH 2023

TIMKEN BEARINGS			
PART NUMBER	DESCRIPTION		PRICE
JM13686	717 Wheel Bearing NEW! (NH 72012)		\$47.47
JMLM102949	Timken Bearing NEW!		\$23.37
JM88107B	Timken Bearing 488 PTO NEW!		Call for Price
JM5C0440LLC3	Timken Bearing for 790 NEW! Blower Idler & 360N New Style Idler (NTN NH87029275)		\$10.41
JMRA100RR	Timken Bearing (NH134130) NEW!		\$24.39
JMLM104949	Timken Bearing with Seal NEW! (NH67372)		\$27.90
JMLM11900LA	Timken Bearing (NH67372) NEW!		\$27.49
JM14137A	Timken Bearing (NH115970) NEW!		\$31.42
JM15112	Timken Bearing (NH29139) NEW!		\$32.74
JM15123	Needle Bearing (NH29140) NEW!		\$16.20
JMTOR.JH1818	Needle Bearing (NH218983) NEW!		\$11.27
JMLM18790	Timken Bearing (NH44419) NEW!		\$43.01
JM2016	Timken Bearing (NH36312) NEW!		\$9.98
JM203KRR2	Timken Bearing (NH66553) NEW! for 892		\$21.82
JM205KRRB2	Timken Bearing NEW! (NH050775 / 50775)		\$10.88
JM25577	Timken Bearing (NH511644) NEW!		\$44.05
JM25580	Timken Bearing (NH13540) NEW!		\$33.67
JM25590	Timken Bearing (NH25590) NEW!		\$31.81
JM25877	Timken Bearing (NH605187) NEW!		\$30.25
JMB2812	Needle Bearing (NH706065) NEW!		\$13.47
JM342A	Timken Bearing (NH115960) NEW!		\$58.03
JM2788	Timken Bearing NEW! for 718 Input Shaft		\$30.62
JMT3780	Bearing (NH174127) NEW!		\$37.03
JM387A	Bearing (NH166258) NEW!		\$36.45
JM44643	Bearing NEW! (NH132710 / 179079 / 92994)		\$10.01
JMLM48500LA	Bearing (NH48977) NEW!		\$24.66
JM501349	Bearing 900-FP230-FP240 NEW! 960 Fan Bearing Inner Wheel Bearing (NH67370 / NH86512015 / Includes LM501310)		\$23.87
JM6010-2RS	Bearing used in 9822699 NEW! Housing 360N-32N Cornheads (NH9800740)		\$31.78
JMLM603049	Bearing NEW! (NH67527 / 86612027 includes 60311)		\$25.72
JM6207-2NSE9	Bearing used on 856366 Shaft NEW! on 360N & 3PN Cornhead (NH84438926)		\$17.52



PRICES SUBJECT TO CHANGE WITHOUT NOTICE

Timken unless noted otherwise.

PRICES MAY NOT LAST THROUGH 2023

TIMKEN BEARINGS

PART NUMBER	DESCRIPTION	PRICE
JM6210-2NSE9	Bearing Harvester Front PTO Bearing (NH12124) NEW!	\$31.91
JM6307-2RS	Bearing (NH320557) NEW!	\$39.88
JMLM6700LA	Bearing Used on 890-892-900-FT230-FP240 Feedrolls (NH48198) NEW!	\$19.80
JM67048	Bearing (NH36726) NEW!	\$10.88
JM68149	Bearing used on FP230-FP240 Wheel Outside NEW!	\$18.20
JMJLM710949C	Bearing (NH221002 / 86577049 – includes JLM710910) NEW!	\$84.42
JM86536196	NH Bearing (Not available in aftermarket) NEW!	\$244.86
JMM86649	Bearing (NH141295) NEW!	\$23.11
JM88107A	Bearing 717 Front PTO Bearing (NH47192) NEW!	\$34.80



TIMKEN RACES

PART NUMBER	DESCRIPTION	PRICE
JM02820	Timken Race (Goes with JM224556 bearing)	\$20.43
JM69310	China Race (Goes with JM69349 bearing)	\$14.83
JM132709	Timken Bearing Race (44610) (Goes with JM132710 bearing)	\$8.65
JM25520C	China Race (Goes with JM25590 bearing)	\$12.10
JM25821C	China Race (Goes with JM25877 bearing)	\$11.90
JM287066	Timken Bearing Race (JLM104911) (Goes with JM199954 bearing)	\$7.98
JM9018	LM29710 Timken Bearing Race In harvester wheels	\$16.00
JM36723T	Timken Race (LM67010) (Goes with 67048 bearing)	\$5.28
JM36723C	China Race (LM67010)	\$3.47
JM36725T	Timken Race (LM11910) (Goes with 11949 bearing)	\$3.96
JM36725C	China Race (LM11910)	\$2.05
JM382A	Timken Bearing Race (Goes with JM166258 bearing)	\$19.10
JM86516467	Timken Bearing Race (48510) (Goes with 86052 bearing)	\$8.69

PRICES SUBJECT TO CHANGE WITHOUT NOTICE

Timken unless noted otherwise.

PRICES MAY NOT LAST THROUGH 2023

TIMKEN RACES			
PART NUMBER	DESCRIPTION		PRICE
JM02820	Timken Race (NH72946) NEW!		\$20.43
JMLM104911	Timken Race (NH287066) NEW!		\$7.98
JM14276	Timken Race (NH116210) NEW!		\$12.04
JM15245	Timken Race (NH28966) NEW!		\$9.90
JM18720T	Timken Race (NH44676) NEW!		\$25.96
JM25520T	Timken Race (NH13958) NEW!		\$17.04
JM25821T	Timken Race (NH605188) NEW!		\$16.81
JM2735X	Timken Race (NH50515) NEW! For 718 Input Shaft		\$27.48
JM29710	Timken Race (NH703623) NEW!		\$16.08
JM332	Timken Race (NH28656 / 46567 / X0107) NEW!		\$25.81
JM3720	Timken Race (NH174125) NEW!		\$21.61
JM382A	Timken Race (NH49029) NEW! For 890 / 892 / 900 / FP230 / FP240 Cutterheads		\$19.24
JMLM501310	Timken Race (NH67371) NEW!		\$6.02
JMLM603011	Timken Race (NHC7526) NEW!		\$14.30
JML68110	Timken Race (NH175508) NEW! For 488 Wobble Box or 68111		\$8.00
JML68111	Timken Race (NH175508) NEW! For 488 Wobble Box or 68110		\$9.43
JMJLM710910	Timken Race (NH221003 / 86577049) NEW! Includes MJLM7109496		\$39.77
JMM86610	Timken Race (NH141296 / 14296) NEW!		\$11.66



OIL SEALS			
PART NUMBER	DESCRIPTION		PRICE
JM9019	14974 Grease Seal Fits 4-lug hub with lip		\$2.79
JM9020	16069 Grease Seal Fits 4-lug hub with flat on back.		\$2.86
JM9021	16289 Grease Seal It is for all 6-lug Amish built wagons and carts		\$2.55
JM9022	20148 Grease Seal It is for pit spreaders etc. (8-lug)		\$4.22
JM12330	Oil Seal (NH36310) NEW! For 900 Attachment Drive Shaft		\$3.83
JM12334	Oil Seal (NH37857) NEW! For 782-790 Reversing Gear Box Output Shaft Seal		\$7.89



PRICES SUBJECT TO CHANGE WITHOUT NOTICE

717.464.1043

OIL SEALS

PART NUMBER	DESCRIPTION	PRICE
JM12485	Oil Seal (NH701519) NEW! For 782-790 Reversing Gearbox	\$7.70
JM16754	Oil Seal (NH166300) NEW! For 718 / 782 / 790 / 890 / 892 Wheel	\$12.67
JM17415	Oil Seal (TCM 17262UH) NEW!	\$8.02
JM16667	Oil Seal (NH46876) NEW! NH Rakes	\$7.25
JM24904	Oil Seal (NH223297) NEW! For 479 Wobble Box	\$10.92
JM340853	Oil Seal (NH46886) NEW! For 360N Head	\$7.02
JM352541	Oil Seal (NH37706 or 181991) NEW!	\$10.30
JM471413	Oil Seal (NH126986) NEW! For 717-718 Gear Box	\$6.51
JM470625	Oil Seal (NH66807) NEW! For 892 Tranny	\$8.09
JM471192	Oil Seal (NH28246) NEW! For 717-718 Gear Box	\$7.72
JM471413	Oil Seal (NH712341) NEW!	\$6.51
JM471652	Oil Seal (NH288875) NEW! For 489 Wobble Box and 360 Idler Sprockets	\$4.86
JM471737	Oil Seal (NH690503) NEW! For 900 / 790 / 824 Head	\$6.96
JM472164	Oil Seal (NH1135955, 13955, 232404, 261336, 261366) NEW!	\$12.33
JM472258	Oil Seal (NH213712, 634036) NEW!	\$8.16
JM472439	Oil Seal (NH 612675) NEW! 900 Gear Box Input Shaft & Cutterhead Drive Shaft	\$9.08
JM472924	Oil Seal (NH58319, 603916, 719864, 77744) NEW!	\$14.99
JM473231	Oil Seal (NH137547) NEW! For 900 Blower Output Shaft	\$7.32
JM473227	Oil Seal (NH272545, 284522, 578751) NEW!	\$8.16
JM473237	Oil Seal (NH225615) NEW!	\$8.41
JM473239	Oil Seal (NH711535) NEW!	\$14.86
JM473313	Oil Seal (NH196286) NEW!	\$20.87
JM474278	Oil Seal (NH136771) NEW! For 892 Tranny	\$7.40
JM481181	Oil Seal (NH616414) NEW!	\$8.42
JM767618	Oil Seal NEW!	\$31.55
JM9822234	Oil Seal For Haybine Gear Box NEW!	\$12.04
JM470380	Oil Seal (NH289189) NEW!	\$4.64



PRICES SUBJECT TO CHANGE WITHOUT NOTICE



*Want
More Milk?*

Process my corn silage and I'll eat one to two pounds less grain per day. I'll have a better butterfat and I will look prettier and be happier! My conception rate should improve too. After all that is done, I'll have a lot more milk for you,
The Dairy Farmer.

Install a *HORNING CROP PROCESSOR...*

...using the saw cut tooth rolls for more ripping power on corn.

***No need to look at cob in the bunk.
Much more consistent feed than unprocessed silage.***

Now Improved!

- » Less Belt Slippage
- » Roll Speed Differential Changed
- » Now Even MORE Ripping Power!

- » We have years of experience in crop processor and New Holland Harvester rebuilding.
- » We install new crop processors and replace worn out processor rolls on any New Holland pull type
- » An average 80-cow herd will pay for a processor in less than 2 years!

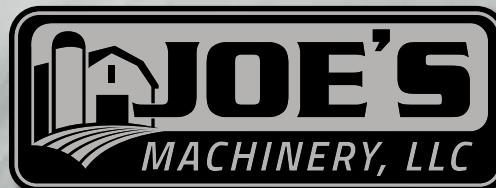

717.464.1043 » 259 Radcliff Rd. » Willow Street, PA 17584

Manufactured in Lancaster County, PA

HORNING CROP PROCESSOR OPERATING INSTRUCTIONS

1. **Shut off all power to machine before servicing**
2. Grease all bearings and zerks every 8 to 10 hours (Roll bearings $\frac{1}{2}$ to 1 pump each)
3. Bearings should operate under 200° F. Spit Test: If it doesn't sizzle (212°), assume normal operation
4. New belts should be checked every hour for the first 5 hours of operation, daily thereafter.
5. Check roll clearance daily.
6. Roll clearance should be $\frac{1}{16}$ " as a starting point.
7. Increase roll gap according to moisture.
8. It may be necessary to lightly tap adjustment blocks downward when decreasing roll gap.
9. Recommended cut length for corn silage is $\frac{3}{4}$ "
10. Emergency stop ($\frac{1}{2}$ " bolt with coupler nut between taper blocks) is factory set to keep rolls from hitting each other. See illustration A.
11. Large processor springs should be compressed to $4\frac{7}{8}$ ". (Rolls should not open under normal conditions)
12. If knives, etc. go through processor, measure springs. (Free length should be $5\frac{1}{4}$ ". Replace springs if less.)
13. Wash down unit at end of season and apply a coating of oil or grease to all unpainted surfaces, especially rolls.

Change over to Haylage

1. Release spring-loaded pins, and remove pan between auger and processor. (You may have to rotate auger to clear pan handle and latches.)
2. Slide air gap angle underneath cutterhead all the way back to improve air flow. Refer to harvester manual.
3. Remove belts for haylage.

Belt Tension

Tensioner spring should be compressed to $\frac{1}{8}$ " gap between spacer and washer. If your machine doesn't have a spacer, press down all belts at once. Belts should deflect $\frac{1}{4}$ " with 25 lbs. down pressure (4-belt model). See illustration below.

For ease of belt installation, adjust rolls completely together.

*Belts should deflect
 $\frac{1}{4}$ " with 25 lbs.
down pressure*

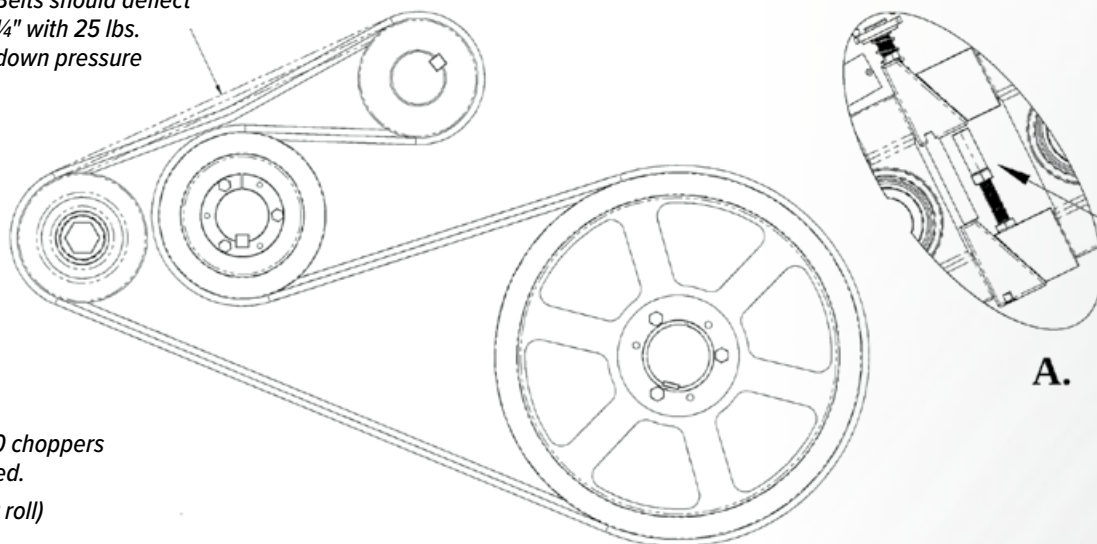

*2013 and prior, on 900 choppers
opposite roll high speed.
(Larger pulley on front roll)*

*Don't overgrease these processor roll bearings. ½ pump a day is plenty.
To save your rolls, winterize them properly by cleaning as soon as you are done in the fall.
Clean, then grease for the winter.*

Call for processor prices, installation and rebuild services!

Processing your corn silage has never been more necessary!

With the price of corn, why would you put it through the cow unused? They keep breeding corn for quicker kernel dry down to pay less at the grain bins for drying. Therefore, the kernel is ready before the stalk for corn silage! A lot of people get caught with kernels that are too dry.

ABOUT BELT KITS

BB 108K-4 Belt Kit is used on all 890-892 Harvesters on all FP230-FP240 2015 and earlier models.

FP230-240 used BB118K-4 on 2016 models and later.

900s used BB105 K-4 before 2005.

Then BB 108K-4 was used from there on except if the large pulley measures: 13.6". If so, then use BB-108 • 15.6" use BB-118

On all 782-790 Harvesters, use BB108-K3

HORNING CROP PROCESSOR TROUBLESHOOTING

Problem	Possible Cause	Solution
Hot bearings	Side strain from improper installation	Loosen collars to release strain, then re-tighten
	Over greasing	Use only ½ to 1 pump of grease per bearing
Plugging in front of rolls	Feed pan not installed properly	Position properly on top of lid
	Dried material on pan from previous season	Clean pan
	Knives too far from pan	Reset knives
	Roll teeth worn dull	Replace rolls
Processor rattles excessively when under load, from springs opening up	Springs too loose or smashed from foreign material	Measure free length of springs. If less than 5¼", replace springs
	Too long cob pieces	Reduce cut length to ¾"
	Rolls set too close for volume of crop	Adjust roll gap
Belts twisting, breaking or getting hot	Misaligned sheaves	Align sheaves
	Belts too tight	Properly adjust belt tension
	Pan bent or out of line	

Contact your dealer about any additional problems.

CHECKING PAN ALIGNMENT

NOTE: to check pan alignment, lay flexible ruler on inside of pan when installed. Slide ruler up toward roll till it hits, then feel where the ruler is hitting on roll. Should be within 1¼" of center of rolls. *Always wear gloves.*

HORNING CROP PROCESSOR AFTERMARKET REPLACEMENT PARTS

New Holland® is a Registered Trademark of CNH Industrial America LLC which does not manufacture or endorse these parts.

PART NUMBER	DESCRIPTION	PRICE	
JM42301	Pan Latch L-Pin NEW!	\$9.12	
JM42306	3.0 KP Idler Arm with 4-B Pulley and Pin NEW!	\$164.64	
JM42336	790 Haylage Shield To Protect Rolls from Haylage Dirt NEW!	\$107.66	
JM42337	892 Haylage Shield NEW!	\$119.16	
JM42338	FP 230 & 900 Haylage Shield NEW!	\$203.11	
JM42339	FP 240 Haylage Shield NEW!	\$223.04	
JM42350	FP 240 Pan NEW!	\$214.05	
JM42351	FP230 & 900 Pan NEW!	\$188.24	
JM42352	NH 892 Pan NEW!	\$174.26	
JM42353	NH 790 Pan NEW!	\$180.69	

PRICES SUBJECT TO CHANGE WITHOUT NOTICE

HORNING CROP PROCESSOR AFTERMARKET REPLACEMENT PARTS

PART NUMBER	DESCRIPTION	PRICE	
JM42356	FP 240 Return Hood NEW!	\$182.59	
JM42357	FP230 & 900 Return Hood NEW!	\$178.72	
JM 42358	NH 892 Return Hood NEW!	\$149.56	
JM42359	Return Hood NEW!	\$156.01	
JM42370	NH 900 & 892 Drive Adapter NEW!	\$119.24	
JM42371	NH 790 Drive Adapter NEW!	\$119.80	
JM42423	Adjustment Lock Plate – Zinc NEW!	\$10.92	
JM42424	Taper Block Adj. Assembly (With Bolt, Spring, & Catcher) NEW!	\$186.48	
JM42425	3.0 KP Idler Arm with 3-B Pulley and Pin NEW!	\$268.08	
JM42436	211's Heavy-Duty Pillowblock Bearing Housing NEW!	\$112.69	
JMBB108K-3	3 Belts Set Fits all 790 Processors NEW!	\$151.20 per set	

PRICES SUBJECT TO CHANGE WITHOUT NOTICE

717.464.1043

HORNING CROP PROCESSOR AFTERMARKET REPLACEMENT PARTS

PART NUMBER	DESCRIPTION	PRICE		
JMBB108K-4	4 Belts Set NEW! Fits all 892 Processors - All 900 processors 2005 through 2015 Select 2016 & Later Most 2005 & Prior Copy	\$224.23 per set		
JMBB118K-4	4 Belts Set NEW! Fits all 3.0 series FP230 & FP240-Most 900 3.0 series 900 All John Deere 3960 through 75	\$271.01 per set		
JMBR2112	Roll Replacement Bearing Insert NEW! Fits all Horning Processors	\$81.35		
JMBR2112PBBDH	Pillow Block Bearing NEW! Fits all Horning processors	\$197.53		
JMBR2112PBBDZ	Pillow Block Bearing NEW! Fits All Horning Processors	\$189.28		
JMBR63042RS	Replacement Bearing NEW! For all Horning Processor Idler Pulleys	\$18.02		
JMBUSD134	Roll Bushing NEW!	\$21.54		
JMBUSK134	Roll Bushing NEW!	\$29.11		
JMCS20x- 80mm10.9	20x80mm Bolt for Idler Pulley NEW!	\$4.29		
JMCS34x14GR8	34" x 14" NC Gr.8 Spring Bolt NEW!	\$29.94		
JMCS34x15GR8	34" x 15" NC Gr.8 Spring Bolt NEW!	\$29.82		
JMCS716X112G8	7/16 x 1 1/2 Gr.8 Bolt NEW!	\$1.02		
JMD1035	2x3 Red Reflective Decal NEW!	\$1.11		

PRICES SUBJECT TO CHANGE WITHOUT NOTICE











HORNING CROP PROCESSOR AFTERMARKET REPLACEMENT PARTS

PART NUMBER	DESCRIPTION	PRICE		
JMD1039	Warning Sharp Rolls NEW! (orange & white)	\$4.76	 <p>JMD1039</p>	 <p>JMD1040</p>
JMD1040	Warning Rotating Parts NEW! (orange & white)	\$3.97		
JMFW34G8	34 Gr8 Flat Washer NEW! For Springs	\$1.08		
JMGH12	12" Grease Hose NEW! 18" NPT Male Both Ends	\$17.88		
JMHC371	Rubber Catcher NEW! & Keeper	\$12.10		
JM42336	Horning Part NEW!	\$107.66		
JMLN34S	34 Stover Locknut NEW! (steel)	\$1.17		
JMLN38S	38 Stover Locknut NEW! (steel)	\$0.21		
JMM4532	6 Bolt 2" Bore NEW! 4 Hole Hub Bushing	\$67.69		
JMP463BIP	3 Groove Idler Pulley (Complete) NEW! Fits all Horning 3 groove drives	\$143.54		
JMP464BIP4.6	4.6 4-Groove Idler Pulley with Bearings NEW!	\$139.14		
JMP464BIP	4-Groove Idler Pulley (Complete) NEW! Fits all Horning 4 groove drives	\$139.14		
JMP544BK	5.4" 4-B SD Sheave NEW! w2 bushing and keyway	\$82.25		
JMP684BK	6.8" 4-B SD Sheave NEW! w2 bushing and keyway	\$101.57		

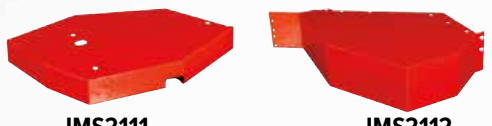
PRICES SUBJECT TO CHANGE WITHOUT NOTICE

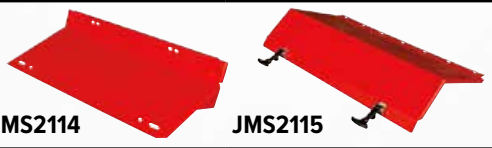

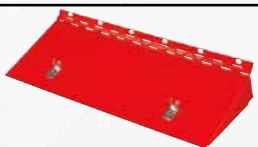

717.464.1043

HORNING CROP PROCESSOR AFTERMARKET REPLACEMENT PARTS

PART NUMBER	DESCRIPTION	PRICE	
JMS2101	NH 790 Top Right Shield NEW!	\$184.80	
JMS2102	NH 790 Top Center Shield NEW!	\$247.98	
JMS2103	NH 790 Left Shield NEW!	\$146.14	
JMS2104	NH 790 Bottom Right Shield NEW!	\$196.50	
JMS2105	NH 892 Left shield NEW!	\$146.36	
JMS2106	NH 892 Top Center Shield NEW!	\$227.38	
JMS2107	NH 892 Right Shield NEW!	\$333.20	
JMS2108	NH 900 Right Shield NEW!	\$220.19	
JMS2109	NH 900 Left Shield NEW!	\$159.62	
JMS2110	NH 900 & FP230 Center Shield NEW!	\$239.56	
JMS2111	NH FP230 & 240 Left Shield NEW!	\$174.43	
JMS2112	NH FP230 & 240 Right Shield NEW!	\$184.91	
JMS2113	NH FP 230 Top Front Shield - NEW!	\$260.40	
JMS2114	NH FP 240 Top Front Shield NEW!	\$251.17	
JMS2115	NH FP 240 Top Back Shield NEW!	\$215.16	
JMS2120	NH 790 Lower Back Lid NEW!	\$183.42	
JMS2121	NH 892 Lower Back Lid NEW!	\$170.48	
JMS2122	NH 900 Lower Back Lid NEW!	\$205.48	

PRICES SUBJECT TO CHANGE WITHOUT NOTICE

HORNING CROP PROCESSOR AFTERMARKET REPLACEMENT PARTS

PART NUMBER	DESCRIPTION	PRICE	
JMS2123	FP230 Lower Back Lid NEW!	\$158.54	
JMS2124	FP240 Lower Back Lid NEW!	\$167.96	
JMSP55	Processor Spring. NEW! Used in all Horning Processors	\$23.60	
JMWR12x1	Pushnut To use with Pan Latch L-pin NEW!	\$1.85	

PART NUMBER	DESCRIPTION	PRICE	
JM9028	NH FP240 Oval Cut Replacement Rolls	\$1393.79 each	[PHOTO NOT AVAILABLE]
JM9029	NH FP230 Oval Cut Replacement Rolls	\$1257.57 each	[PHOTO NOT AVAILABLE]
JM9030	NH 900 Replacement Rolls	\$1257.57	Call for details.
JM9031	NH 892 Replacement Rolls	\$1242.77	
JM9032	NH 790 Replacement Rolls	\$1201.43	

PRICES SUBJECT TO CHANGE WITHOUT NOTICE

717.464.1043

AFTERMARKET REPLACEMENT CHOPPER PTOs AND PARTS

New Holland® is a Registered Trademark of CNH Industrial America LLC which does not manufacture or endorse these parts.

NH717-718 AFTERMARKET REPLACEMENT PARTS

PART NUMBER	DESCRIPTION	PRICE	
JM24527P	NH717-718 Primary Shaft	\$833.25	
JM165354	Front Yoke on Long Shaft	\$239.25	
JM29215	35 Series Cross & Bearing Kit	\$27.32	

The JM165354 and or JM29215 are used on all 1¼ long PTO shafts. For 1⅜ long PTO shafts, use the same parts as 782, 790, 890, 892 PTOs

NH782, 790, 890, 892 AFTERMARKET REPLACEMENT PARTS

PART NUMBER	DESCRIPTION	PRICE	
JM24626P	NH782, 790, 890, 892 Primary Shaft Specify if you want 1⅜-21 or 1⅜-6 or 1¼-20 yoke to go to tractor	\$1177.00	
JM136989	Front PTO Yoke	\$369.60	
JM855838	Front 1000 RPM 13/8 Yoke 2600 Series	\$141.62	
JM856130	Front 1000 RPM 13/4 Yoke 2600 Series	\$198.00	
JM1022606	Front 540 RPM 13/8 Yoke 2600 Series	\$124.01	
JM126761	2600 Series Cross & Bearing Kit	\$64.73	

NH900 AFTERMARKET REPLACEMENT PARTS



PART NUMBER	DESCRIPTION	PRICE	
JM24623P	NH900 Primary Shaft with 1⅜-21	\$1152.00	
JM24723P	NH900 Primary Shaft with 1¼-20	\$1177.00	
JM24625P	NH900 Primary Shaft without rear yoke. It is a 2600 series, so if you need a rear yoke, it is part #JM634994	\$1195.00	

Always ask customer what tractor PTO he has.

JM634994	Yoke on Long PTO on 900 BSN909054	\$235.00	
----------	---	----------	---

PRICES SUBJECT TO CHANGE WITHOUT NOTICE

NH900 AFTERMARKET REPLACEMENT PARTS

PART NUMBER	DESCRIPTION	PRICE	
JM9841805	Yoke on Long PTO on 900 ASN 909055	\$238.57	
JM126761	2600 Series Cross & Bearing Kit	\$64.73	
JM2005500	55 Series Cross & Bearing Kit	\$52.85	
JM1022620	1 $\frac{3}{4}$ -20 2600 Series Yoke for on Tractor	\$174.00	  
JM1022621	1 $\frac{3}{8}$ -21 2600 Series Yoke for on Tractor	\$137.36	
JM1025520	1 $\frac{3}{4}$ -20 5500 Series Yoke for on Tractor	\$243.60	
JM1025521	1 $\frac{3}{8}$ -21 5500 Series Yoke for on Tractor	\$143.55	

NH230-240 AFTERMARKET REPLACEMENT PARTS

PART NUMBER	DESCRIPTION	PRICE	
JM24624P	FP230-240 Primary Shaft 1 $\frac{3}{8}$ -21	\$885.00	
JM24724P	FP230-240 Primary Shaft 1 $\frac{3}{4}$ -20	\$912.00	
JM1025520	1 $\frac{3}{4}$ -20 5500 Series Yoke for on Tractor	\$243.60	  
JM1025521	1 $\frac{3}{8}$ -21 5500 Series Yoke for on Tractor	\$143.55	
JM2005500	55 Series Cross & Bearing Kit	\$52.85	

PART NUMBER	DESCRIPTION	PRICE	
JM86579851	Cornhead Drive PTO	\$566.95	

NH790 Parts

JM24P528WL - 1 $\frac{3}{8}$ - 6 Spline

JM24P628WL - 1 $\frac{3}{8}$ - 21 Spline

These two parts are splined and used on all 790 choppers.

Call if you cannot find what you are looking for.

All PTOs are Weasler brand and of the highest quality!

Go to page 141 for the shields you need separately.

PRICES SUBJECT TO CHANGE WITHOUT NOTICE

717.464.1043

AFTERMARKET REPLACEMENT CHOPPER PTOs AND PARTS

HEAVY-DUTY HIGH-QUALITY PTO AFTERMARKET REPLACEMENT PARTS

PART NUMBER	DESCRIPTION	PRICE
JM200-0600	High-Quality Cross & Bearing Kit	\$18.96
JM200-0675	High-Quality Cross & Bearing Kit Fits Hay Rakes Between Wheels	\$20.22
JM200-1200	High-Quality Cross & Bearing Kit Very Standard on Farm Equipment	\$17.37
JM200-1400	High-Quality Cross & Bearing Kit Very Standard on Farm Equipment	\$22.68
JM200-1875	High-Quality Cross & Bearing Kit fits 402 Crimpers and Some Haybines	\$27.08
JM200-2600	High-Quality Cross & Bearing Kit 718, 782, 790, 890, 892, 900 Choppers	\$64.73
JM200-3500	High-Quality Cross & Bearing Kit fits Most 717-718 Choppers	\$27.32
JM200-4400	High-Quality Cross & Bearing Kit	\$26.92
JM200-5500	High-Quality Cross & Bearing Kit	\$52.85
JM136908	1200 Series Cross & Bearing Kit , fits on chopper feedrolls with zerk on cap!	\$24.95



RAKES AND TEDDERS

PART NUMBER	DESCRIPTION	PRICE
JM98522P	(8000 inch pounds) 1 3/8 x 6 Spline on Both Ends You can cut to length!	\$448.80
JM98526P	(14,160 inch pounds) You can cut to length!	\$610.50



NEW HOLLAND AFTERMARKET REPLACEMENT GRINDER MIXERS

PART NUMBER	DESCRIPTION	PRICE
JM29522P	Fits on later serial #352 and on 353, 354, 355, 357, 358	\$1268.85



DOMESTIC CROSS KITS

SERIES #	PART # STANDARD	RATED HP @540 S KIT	RATED HP @540 EL KIT	RATED HP @1000 S KIT	RATED HP @1000 EL KIT	(A) BEARING DIAMETER	(B) CAP TO CAP OVERALL LENGTH
6N	MAM6	14	19	21	29	0.97 in. / 24.6 mm	2.28 in. / 57.9 mm
1000N	MAM1000N	16		30		0.94 in. / 23.8 mm	2.31 in. / 58.7 mm
12N	MAM12	19	26	29	40	1.06 in. / 27.0 mm	2.50 in. / 63.5 mm
1800N	MAM1800N	35		48		1 in. / 25.4 mm	3.22 in. / 81.8 mm
14N	MAM14	28	38	44	58	1.13 in. / 28.6 mm	2.63 in. / 66.7 mm
35N	MAM35	51	70	79	108	1.25 in. / 31.8 mm	3.22 in. / 81.8 mm
44N	MAM44	77	103	119	158	1.31 in. / 33.3 mm	4.00 in. / 101.6 mm
2600N	MAM2600N	100		150		1.38 in. / 34.9 mm	4.19 in. / 106.4 mm
55N	MAM55	106	137	164	211	1.53 in. / 38.9mm	4.31 in. / 109.5 mm

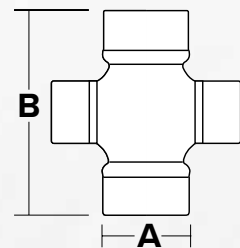

PRICES SUBJECT TO CHANGE WITHOUT NOTICE

NEAPCO STANDARD SHIELDS

PART NUMBER	DESCRIPTION	PRICE
JM69-0648	Bare-Co & Bondioli #1 – #2 Walterscheid W2100 Domestic 6N & 100N	\$98.49
JM69-1248	Bare-Co & Bondioli #3 – #4 Walterscheid W2200 – W2300 Domestic 12N, 14N, 1800N	\$86.34
JM69-2248	Bare-Co & Bondioli #5 – #7 Walterscheid W2400 – W2500 Domestic 35N	\$129.54
JM69-2648	Bare-Co & Bondioli #8 <i>Fits most NH choppers.</i> Domestic 44N, 55N, 2600N	\$206.91



NEAPCO STANDARD SHIELD BEARINGS

PART NUMBER	DESCRIPTION	PRICE
JM56-2101	Bare & Bondioli #1	\$24.02
JM56-2102	#2	\$17.75
JM56-4103	#3, 4	\$17.09
JM56-6105	#5	\$22.70
JM56-6106	#6, 7	\$25.00
JM56-8108	#8	\$31.83
JM56-2122	Walterscheid W2100	\$17.03
JM56-2223	W2200, W2300	\$22.79
JM56-2324	W2400, W2500	\$23.48
JM56-1600	Domestic 6N	\$11.31
JM56-0600	1000N	\$13.13
JM56-2000	12N, 14N, 1800N	\$14.29
JM56-2200	35N	\$18.74
JM56-0844	44N, 55N	\$19.42
JM56-2600	2600N <i>Fits together with JM69-2648 on choppers.</i>	\$22.61



PLAY IT SAFE! Shield your equipment!

LEVER RELEASE GUARDS

PART NUMBER	LENGTH		APPLICATION	PRICE
	LENGTH	Center of Bearing Groove to Center of Bearing Groove		
JMAS20090	36"-48"	32"	Standard Shield	\$81.43
JMAS20130	51"-60"	45"	Bare-Co and Bondioli #1 – #4 Walt: up to W2300 USA: 6N – 12N	\$88.23
JMAS20180	79"-134"	65"		\$117.63
JMAS30090	36"-48"	30"	Standard Shield	\$110.85
JMAS30130	51"-60"	42"	Bare-Co and Bondioli #5 – #10 Walt: W2400 to W2600 USA: 14N – 55N	\$115.37
JMAS30180	79"-134"	61"		\$140.25
JMASW3100			#4, W2380 CV Guard	\$162.87
JMASW7100			#6, #8, W2480, W2580 CV Guard	\$176.65



Call with your needs!

PRICES SUBJECT TO CHANGE WITHOUT NOTICE

717.464.1043

MECHANICAL TRANSPLANTERS

New or Rebuilt with Your Choice of
Tongue on Front, or Tractor Hitch

*Always keep your planter shoe in
like-new condition and work your
ground loose for maximum performance!*



Options

- » Trays on Front or Back as Shown
- » Steel or Rubber Wheels
- » 6 – 8 – 10 – or 12 Plant Pockets
- » 55 to 110 Gallon Poly Water Tank

Now standard with slip-in aluminum
tongue and down pressure lever



**This down pressure lever
is designed to put your unit in
the ground with force!**

The spring lets the unit come up when going over a stone, etc. If you have problems with your drive wheels sliding, just put your lever down another notch. Customers are getting more pounds per acre with a mechanical planter than with a New Idea Planter, as all plants are spaced evenly.

**We Build
Planters!**



717. 464 .1043 » 259 Radcliff Rd. » Willow Street, PA 17584

MECHANICAL PLANTER ADJUSTMENTS

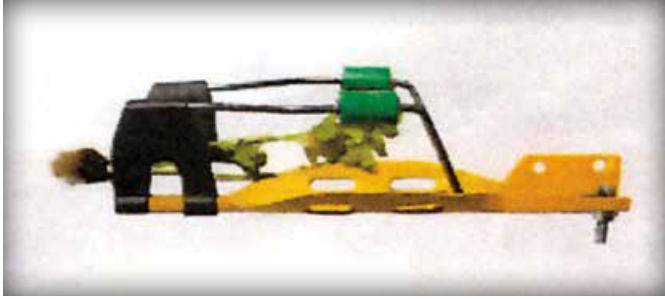

V-3 Standard Plant Placement



Deeper Plant Placement

Pocket Chain Instructions

1. Make sure that bolts holding the upper sprocket on the pocket chain are not too tight. This will cause unnecessary friction on the unit and possible slippage on packing wheel drive transplanter. Loosen the wing nuts if the chain seems too tight.
2. Tighten the wingnuts equally by the top sprocket to keep the chain running level at all times.
3. If in row spacings of 20" or greater are needed, use only 6 pockets. You may remove every other pocket or leave them on. This gives the same speed or greater as a 12 pocket chain.

Adjusting or setting the #395R Round Point Shoe

Note: The shoe is preset at the factory for almost all situations.

Follow these instructions only if plants are leaning or in extreme wet or dry soil conditions.

1. Whenever any adjustments are made, be sure to get the shoe directly square and straight in front of the opening of the packing wheels. Make sure that the pockets will run through the middle of the shoe.
2. In loose dry soil, the shoe should be adjusted closer to the packing wheel. This can be done by adjusting the diagonal brace on the shoe.
3. In wet heavy soil, the shoe should be adjusted away from the packing wheels. This can be done by adjusting the diagonal shoe brace.
4. Keep the shoe clean at all times. Do not allow dirt or trash to build up on the front or side of the shoe because this can cause too wide of a furrow that cannot be closed properly by the packing wheels. Poly covered shoes will eliminate this problem.

Water Valve Adjustment

1. For more water, make sure the valve is getting a full stroke by adjusting the #604 bracket on the pump rod. Make sure the valve does not over stroke. You should be able to lift the #604 rod $\frac{1}{4}$ " to $\frac{1}{2}$ " at the top of its stroke.
2. A broad range of adjustment can be achieved with the #603 water cam.
3. For wider spacings, the water cam may have to be raised so the water is on the plant. If the #603 is raised, be sure to raise the #604 water adjustment bracket accordingly and do not over stroke.
4. Tilting the #603 water cam back towards the water trips on the pockets will create a longer stroke of water or more water before and after the plant.
5. **Always empty the water out of the valve after quitting for the day. Water freezing inside the valve will destroy the #610S and #612 balls inside the valve.**

Proper Planting Position

1. Run the unit frame level to the ground. This allows the packing wheels to run in the proper packing position.
2. Running the toolbar too low will cause the packing wheels to run too light and not to drive or pack the soil properly.
3. Running the toolbar too high will cause the unit to not float properly, especially through low spots.
4. For proper float, lengthen your top third arm to tilt the clamp hitch back. You should have $\frac{1}{4}$ " to $\frac{1}{2}$ " of space between the pick up plate on the bottom of your clamp hitch. When the clamp is tilted back, the frame must tilt parallel to the ground when the unit is in the soil and ready to plant.

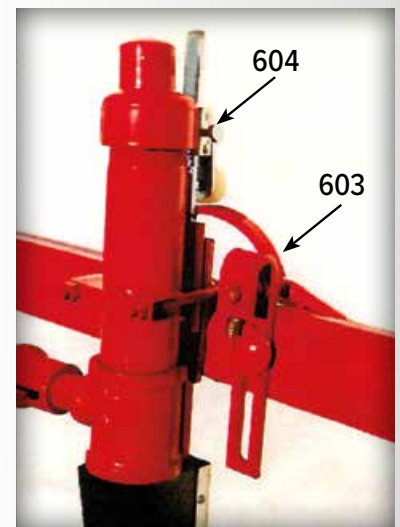

Example: At 20" plant spacing, the #603 water cam should be adjusted nearly all the way up the slot. The #604 water adjustment must also be adjusted accordingly so a $\frac{1}{2}$ " remains on the #604 stroke.

MECHANICAL PLANTER TROUBLESHOOTING

Problem

Solution

Packing wheels not packing properly

- A. Lengthen third arm on tractor to get float in hitch
- B. Hitch is too far down and needs to be lifted
- C. Clean off side of shoe
- D. Work soil deeper
- E. Add weight to back of unit
- F. Poly shoes will eliminate soil building up on the outsides

Water leaks from top of water valve

We now offer a different solution!

- A. Check to see if the rubber nipple inside the top of the valve is in place and rounded.
- B. #610 ball inside the valve has collapsed and needs to be replaced.

Water leaks from bottom of water valve

- A. Rubber ball #812 on pin is broke and needs to be replaced
- B. The nylon nut on the bottom is broken and needs to be replaced

Water not uniform

- A. Make sure all the water trips on the pockets are in good shape and at even distance from the attachment link.
- B. Check to see that all springs on the water valve are in good working order.
- C. Water valve has dirt or residue build up that needs to be cleaned out

Plants falling out of pocket

- A. Inspect the rubber grippers to make sure that they are not all stretched out,
- B. Tighten the L-bolt on the side of the guides.
- C. #482 pocket extension may be needed if planting cell-type plants.
- D. Check bottom of guides to insure that the pocket is not releasing the plant too soon.

Plants on top of soil

- A. Cut back on water because the plants are floating up out of the shoe.
- B. Plants need to be pulled further out of the pocket to put them deeper.
- C. Too much loose soil is getting inside the shoe before the packing wheels can pack. Move shoe closer to packing wheels.
- D. A gap might be occurring by having the hitch too low causing the packing wheels to be up in the air or not being able to put enough pressure on the soil.
- E. Ground not worked deep enough causing the shoe to not go deep enough into the soil.
- F. Our OE 73 weight bracket will help get the shoe deeper

Plants leaning

- A. Need to put plant further in the pocket to keep it from hitting the bottom of the furrow,
- B. Possibility of needing a deeper shoe.
- C. May need #482 extensions to help support the cell of a plant coming from a tray.

Packing wheel drive slippage

- A. Models with Direct Drive Float Wheels eliminate this problem.
- B. Extra weight may be needed to keep the packing wheels down,
- C. Make sure the frame of the unit is running parallel to the ground.
- D. Check to see if the third arm on the tractor is adjusted to allow float in unit hitch.

PLANT SETTING CHARTS

PLANTS PER ACRE (These are estimated numbers only)								
PLANT SPACING IN INCHES	SPACING BETWEEN THE ROWS IN INCHES							
	26	28	30	32	34	36	38	40
10	24,066	22,453	20,942	19,621	18,457	17,424	16,500	15,669
12	20,073	18,958	17,424	16,314	15,392	14,520	13,741	13,081
14	17,217	16,014	14,917	14,006	13,160	12,445	13,741	13,081
16	15,072	14,006	13,081	12,235	11,523	10,890	10,322	9,810
18	13,403	12,445	11,616	10,890	10,249	9,280	9,170	8,712
20	12,066	11,197	10,446	9,810	9,228	8,712	8,250	7,834
22	10,972	10,177	9,510	8,905	8,393	7,920	7,497	7,129
24	10,060	9,327	8,712	8,172	7,682	7,260	6,881	6,530
26	9,287	8,608	8,036	7,536	7,094	6,701	6,349	6,033
28	8,608	8,007	7,471	7,003	6,590	6,222	5,894	5,598
30	8,036	7,471	6,969	6,530	6,152	5,808	5,500	5,225
32	7,536	6,003	6,530	6,126	5,761	5,445	5,161	4,899
34	7,094	6,590	6,152	5,761	5,424	5,124	4,856	4,614
36	6,701	6,222	5,808	5,445	5,124	4,840	4,585	4,356
38	6,349	5,894	5,500	5,161	4,856	4,585	4,324	4,125
40	6,033	5,598	5,229	4,889	4,614	4,356	4,125	3,920
42	5,746	5,331	4,978	4,668	4,391	4,184	3,931	3,732
44	5,486	5,088	4,750	4,453	4,192	3,960	3,751	3,564
46	5,241	4,872	4,546	4,262	4,011	3,787	3,588	3,408
48	5,024	4,668	4,356	4,082	3,844	3,630	3,438	3,268

For any other number of plants per acre:

Take the plant spacing and multiply by the row spacing, then divide by 144 = (answer)

Then, 43560 divide by (answer) = _____

We set our new mechanical planter at 7920 plants per acre. The **six circled numbers** in the charts on this page show our settings.

MECHANICAL SETTINGS For units prior to 1990 chain plant spacing chart						
POCKETS ON CHAIN	NUMBER OF TEETH ON SPACING SPROCKET					
	6	7	8	9	10	11
10	10"	12"	14"	16"	18"	20"
8	14"	16"	18"	20"	22"	24"
6	18"	20"	22"	24"	26"	28"
4	28"	32"	36"	40"	44"	48"

MECHANICAL TRANSPLANTER PARTS

PART NUMBER	DESCRIPTION	PRICE	
	Complete Pocket Chain NEW! with cube extension, separating bars, water trip		
JM6	6 Pocket	\$310.85	
JM8	8 Pocket	\$394.85	
JM10	10 Pocket	\$478.83	
JM21	Down Pressure Spring Holder NEW!	\$31.64	
JM22	Packer Wheel Spindle NEW! (Specify RH or LH)	\$39.16	
JM22R	Packer Wheel Shaft NEW! 8" long Shorter shaft for down pressure lever 5 3/4" long	\$14.43	
JM24	Notch Steel Part for Lever NEW!	\$33.91	
JM25	Flat with Adjusting Holes NEW! with 1 Bushing	\$40.89	
JM325	Steel Drive Chain – 21 Links NEW! (#32 Ag)	\$33.83	
JM348	Lower Drive Shaft NEW!	\$14.62	
JM355	Lower Drive Sprocket NEW!	\$32.07	
JM362	Lower Drive Shaft Bronze Bushing NEW! B12148	\$1.90	
JM373	Chain Tightener Spring NEW!	\$6.15	
JM375	Water Trip NEW!	\$3.80	

PRICES SUBJECT TO CHANGE WITHOUT NOTICE

PART NUMBER	DESCRIPTION	PRICE	
JM377S10	10 Attachment Steel Conveyor Chain NEW!	\$73.12	
JM377S6	6 Attachment Steel Conveyor Chain NEW!	\$63.93	
JM377S8	8 Attachment Steel Conveyor Chain NEW!	\$67.02	
JM381-6	6 Tooth Steel Spacing Sprocket NEW!	\$13.85	
JM379	Upper Conveyor Sprocket NEW!	\$20.08	
JM380	Top Idler Shaft (For pocket Chain) NEW!	\$14.44	
JM381-7	7 Tooth Steel Spacing Sprocket NEW!	\$9.28	
JM382	8 Tooth Steel Spacing Sprocket NEW!	\$9.34	
JM383	9 Tooth Steel Spacing Sprocket NEW!	\$9.34	
JM384	10 Tooth Steel Spacing Sprocket NEW!	\$9.63	
JM385	11 Tooth Steel Spacing Sprocket NEW!	\$9.63	
JM385-12	12 Tooth Steel Spacing Sprocket NEW!	\$44.12	

PRICES SUBJECT TO CHANGE WITHOUT NOTICE

717.464.1043

MECHANICAL TRANSPLANTER PARTS

PART NUMBER	DESCRIPTION	PRICE	IMAGE	
JM395R	7" Round Point Shoe NEW!	\$135.00		
JM408	Dirt Shield NEW!	\$21.68		
JM421L	LH Chain Tightner NEW! Note: This is for RH standing behind planter	\$18.37	 JM421L LH	 JM420R RH
JM420R	RH Chain Tightner NEW! Note: This is for LH standing behind planter	\$18.37		
JM434	7/8" Oilite Packer Wheel Bushing NEW!	\$4.50		
JM436B	L-Bolt NEW! For Pocket Guide	\$4.71		
JM436L	Pocket Guide NEW!	\$66.50	 JM436L LH	 JM436R RH
JM436R	Pocket Guide NEW!	\$66.50		
JM440	Wire Rollers NEW!	\$10.95		
JM445	Rubber Gripper NEW!	\$7.86		
JM452	3 1/2" Spacer NEW! To fit between JM453	\$4.35		
JM453	Upright Arm NEW! (Specify LH or RH)	\$33.94		
JM461	J-Bolt for Wheel Sprocket NEW!	\$0.90		
JM462	Wheel Sprocket NEW!	\$11.34		
JM482	Cube Extension NEW! With bolt, nut, and washer	\$4.71		

PRICES SUBJECT TO CHANGE WITHOUT NOTICE

MECHANICAL TRANSPLANTER PARTS

PART NUMBER	DESCRIPTION	PRICE	
JM529	Packer Wheel Scraper Blade NEW!	\$7.64	
JM530	Packer Wheel Scraper Bracket NEW!	\$19.56	
JM600	Water Works (Complete with cam rocker) NEW!	\$232.93	
JM60289	U-Bracket To hold waterworks NEW!	\$7.80	
JM603	Water Valve Rocker and Cam Only NEW!	\$30.75	
JM605	Water Trip Rod NEW!	\$26.87	
JM611	Water Valve Seat NEW!	\$11.46	
JM60489	Water Adjuster Bracket NEW!	\$24.19	
JM607L	Long Water Trip Spring NEW!	\$6.16	
JM60989	Water Valve Top NEW!	\$19.56	
JM610S	Inside Water Float Ball NEW!	\$2.76	
JM612	Water Valve Ball & Stem NEW!	\$14.53	
JM613	Water Valve Spout NEW!	\$23.39	
JM616S	Cam Spring NEW!	\$6.73	
JM639	Rear Packer Wheel NEW!	\$150.71	

PRICES SUBJECT TO CHANGE WITHOUT NOTICE

717.464.1043

MECHANICAL TRANSPLANTER PARTS

PART NUMBER	DESCRIPTION	PRICE	
JM649D	Shoe Brace NEW!	\$30.58	
JM649F	Shoe Brace NEW! 2 pc. per planter	\$30.91	
JM649R	Shoe Brace NEW! 2 pc. per planter	\$23.46	
JM800	Adjusting Spring Shaft NEW! With welded bushing	\$42.55	
JM801	L-Shaped Seat Bracket NEW!	\$40.44	
JM802	U-Shaped Bracket Clamp NEW! Specify tubing size	\$12.03	
JM803	Seat Bottom Bracket NEW!	\$14.89	
JM804	Main Unit Frame NEW!	\$195.10	
JM805	Row Marker Arm NEW!	\$22.22	
JM806	Row Marker Arm Chain NEW!	\$9.32	
JM807	Row Marker Swivel NEW!	\$8.79	
JM808	Row Marker Point NEW!	\$23.13	
JM809	Water Tank Strap NEW! 2 pc. per planter	\$19.61	
JM810	Stub Tongue NEW! For Aluminum Tongue	\$135.59	
JM811	Aluminum Tongue NEW!	\$199.80	

PRICES SUBJECT TO CHANGE WITHOUT NOTICE

PART NUMBER	DESCRIPTION		PRICE	
JM812	Shregs Tray With 2 mounting angles	NEW!	\$110.58	
JM813	Shregs Tray Mounting Kit (Specify LH or RH)	NEW!	\$77.92	
JM814	Front Dolly Bushing B182010 2 pieces per planter	NEW!	\$3.57	
JM815	Double Rear Tray Holder	NEW!	\$526.47	
JM818	Cast Aluminum Seat	NEW!	\$42.34	
JM819	Pocket Chain Tightner, Bolt, & Spring	NEW!	\$6.01	
JM820	Front Adj. Steering Part (Top)	NEW!	\$26.10	
JM821	Front Dolly Bushing with Zert Includes 2 pc. JM814	NEW!	\$27.00	
JM822	Front Dolly Spindles & 4 Lug Hubs w/ Slide in shaft	NEW!	\$191.55	
JM823	Front Dolly Platform	NEW!	\$112.65	
JM824	Front Dolly Platform Seat Bracket	NEW!	\$48.51	

PRICES SUBJECT TO CHANGE WITHOUT NOTICE

717.464.1043

MECHANICAL TRANSPLANTER PARTS

PART NUMBER	DESCRIPTION	PRICE	
JM825	Front End Dolly V Steel Tube NEW!	\$151.85	
JM828	Down Pressure Lever Assembly Complete NEW!	\$389.28	
JM830	Down Pressure Lever Spring BS-650 NEW!	\$19.94	
JM832	Down Pressure Lever Only with a rod & spring NEW!	\$115.07	
JM834	Down Pressure Spring Clip (CP4) 2 pcs. per kit NEW!	\$2.76	
JM835	Down Pressure Spring Washer MW118WR -- 2 pcs. per kit NEW!	\$1.13	
JM836	7/8" x 22" Shaft NEW! Includes 4 pcs. 7/8" shaft collars (On front of main unit frame)	\$18.96	
JM837	Tank Saddle NEW!	\$92.02	
JM838	Front Wheel (6" x 14" - 4 Lug) NEW!	\$106.54	
JM839	Rear Wheel (6" x 30" - 4 Lug) NEW!	\$163.85	
JM840	Front Adj. Steering Part (Bottom) NEW!	\$48.06	
JM841	100 Gallon Poly Water Tank NEW!	\$420.50	

PRICES SUBJECT TO CHANGE WITHOUT NOTICE

PART NUMBER	DESCRIPTION	PRICE	
JM842	8" Tank Lid 60002 NEW!	\$16.69	
JM843	Water Tank Fitting 1 1/4" FPT 60403 NEW!	\$7.00	
JM844	Elbow Male Hose Adaptor 1 1/4 MPT x 1" Barb, 3EL114100 NEW!	\$5.35	
JM845	3/4" PVC Ball Valve BVF34P NEW!	\$4.45	
JM846	1" Water Hose NEW!	\$5.45 per foot	
JM850	Complete Shregs Tray Kit Include 2 pcs. JM812 & 2 pcs. JM813 plus steel for mounting	\$452.00	[PHOTO NOT AVAILABLE]
JMOE74LB	Fiberglass Seat NEW! Include JM803 for mounting.	\$64.67	
JMSP10	10 Pocket Separating Bar NEW!	\$5.06	
JMSP6	6 Pocket Separating Bar NEW!	\$5.06	
JMSP8	8 Pocket Separating Bar NEW!	\$5.06	
JMV3D	Complete Pocket Yellow (Less separating bar) NEW!	\$32.76	 
JMV3D	Complete Pocket Red (Less separating bar) NEW!	\$32.76	

PRICES SUBJECT TO CHANGE WITHOUT NOTICE

717.464.1043

NH ROLA BAR RAKES

Models 56 - 256 - 258 - 260



This model was completely rebuilt

Options

- » Available with Dolly Wheels or Hitch on Front
- » Available with Steel or Rubber Wheels
- » Available with Steel or Rubber Teeth

We stock a full line of NH Aftermarket Parts for these models!



We have hydraulic drive New Holland rakes with Honda motor or with your hydraulic unit. Call for details!



717.464.1043 » 259 Radcliff Rd. » Willow Street, PA 17584

NH 790 HARVESTER

Metal-Alert®

**Completely Rebuilt and Shown
with our New Style Stainless Steel Gooseneck**



**We also have stainless
steel gooseneck
wear liners.**

- » **Always install our cupped fan paddles for better blowing!**
- » **The performance of our new design upper rear feedroll is much improved for corn and hay.**
- » **The new style upper feedroll driveline kit has been a very good improvement on the 782 and 790 Harvester.**
- » **We can always install a crop processor on your harvester.**

*We stock most of the replacement
parts in NH Aftermarket Parts.*

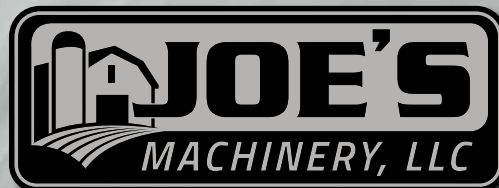

717.464.1043 » 259 Radcliff Rd. » Willow Street, PA 17584

Manufactured in Lancaster County, PA

NH892 HARVESTER WITH FEED TABLE

The Highest Capacity Machine with the Least Maintenance



We manufacture and stock aftermarket parts for all NH pull type harvesters!

We always install our cupped fan paddles for better blowing!

New Holland® Aftermarket Parts



Options

- » **Hydraulic Feed Roll Drive:**
It's easy to adjust your length of cut!
- » **Shear Pin Kit in the Blower:**
No more slippage!
- » Horning Crop Processor
- » Bottom Front Feed Roll Upgrade to a 1 1/4 Shaft
- » Long or Short Tongue

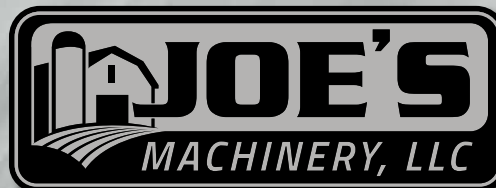

717.464.1043 » 259 Radcliff Rd. » Willow Street, PA 17584

NH456 MOWER

With Vanguard Engine and Clutch Reduction



*Available with Your
Choice of Gas Engines
or Diesel Motors*

Features

- » Has a Self-Contained Hydraulic Unit
- » Your Choice of 7 ft. or 9 ft. Cutting Bar
- » Also Available in 3 Point (450 or 451 Models)
- » Your Choice of Rubber or Steel Wheels

New Holland® Aftermarket Parts

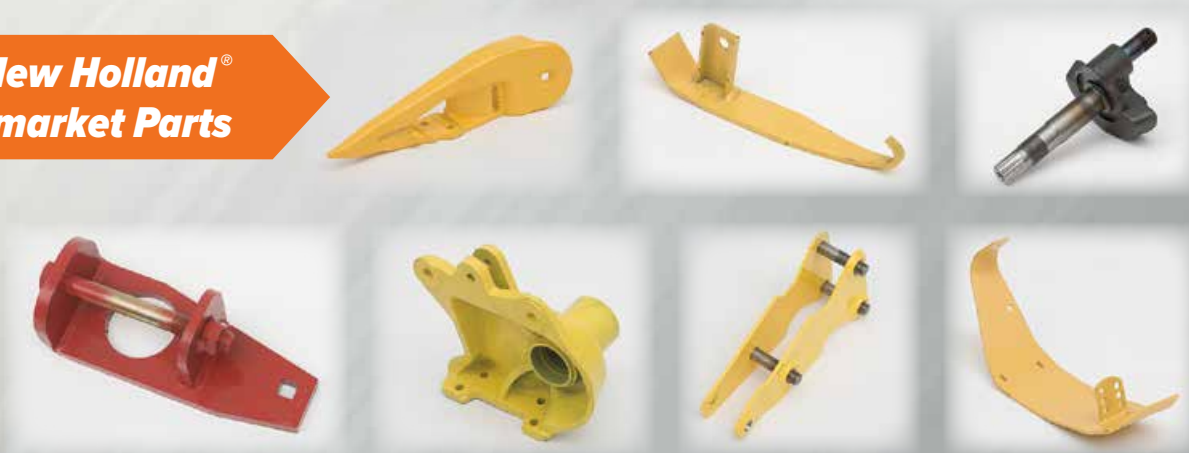

717.464.1043 » 259 Radcliff Rd. » Willow Street, PA 17584

Manufactured in Lancaster County, PA

NEW HOLLAND HAYLAGE CHOPPERS

We Build and Modify NH Harvesters to Fit Into Your Barn Just the Way You Want It!



This unit works great with a round bale unroller.



This unit works great with small square bales.

Benefits

For round bales order with a table.

For small square bales a hopper is sufficient.

- » No more long stem hay in cowbeds and gutter grates
- » It is proven that cows will eat more dry matter and make better butterfat.
- » Easier to get lesser quality hay into the cow.
- » **MORE MILK!**

This unit is equipped with a 35 hp Vanguard motor!



Research shows approximately **\$1,000 to \$1,500 in savings per year** by not wasting your hay to the gutter grates!

Continued research has shown how important it is to chop your hay, and farmers tell us that their actual savings and benefits are far greater than our estimate!

Call for Options Not Shown Here!

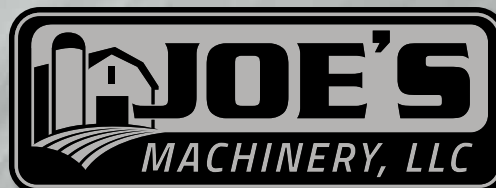

717. 464 .1043 » 259 Radcliff Rd. » Willow Street, PA 17584

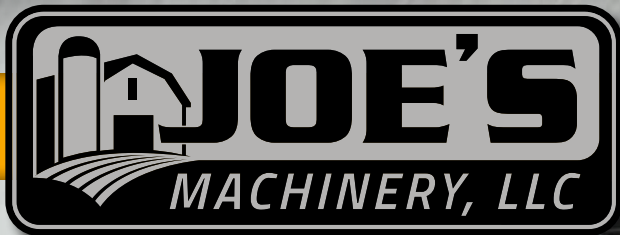

Hi-Moisture Bagger Tonnage Chart

5 ft. Bagger with 190 H.P. tractor,
fuel & 1 person included to help.
6.5 ft. Bagger with 190 H.P. tractor,
fuel & 1 person included to help.



**We Do Custom
Bagging!**

SHELLED CORN – 6.5 ft. Bagger

Tons per 6.5 x 100 ft. Bag60 tons or 2100 bushel
Tons per 6.5 x 150 ft. Bag98 tons or 3430 bushel
Tons per 6.5 x 200 ft. Bag135 tons or 4725 bushel
Approximately 25 Bushels per Filled Foot

SHELLED CORN – 5 FT. BAGGER

Tons per 5 x 100 ft. Bag35 tons or 1225 bushel
Tons per 5 x 150 ft. Bag57 tons or 1995 bushel
Tons per 5 x 200 ft. Bag78 tons or 2730 bushel
Approximately 15.83 Bushels per Filled Foot

Shelled corn at 56 lbs. per bushel shelled corn ÷ by 2000 lbs.
per ton equals = 35 bushel per ton.

5 ft. Bagger is .44 tons per ft. shelled
6.5 ft. Bagger is .75 tons per ft. shelled
For cob, you get approximately 20% more product off
the field.

These figures are only approximate figures and are based on any
moisture of corn. We are not liable if for any reason these figures will
be used to charge your customer for corn and figures are proved to not
being true! We will shell your pile of corn in the fall, then grind and bag it!

Ag Choice Applicator

Has an auger for less maintenance
and is competitively priced with
the original gandy.

(This is for dry inoculant only)

These applicators are ready to put on your
baler, chopper, blower, bagger, corn planter
and more.

We sell parts for these baggers. The mill
parts will also fit your Gehl grinder mixer.



NEW STYLE TANDEM RAKE HITCH



**Safety lock with
a simple hitch pin**

**Two hoses from tractor
to rear cylinder.**



**14³/₄" spread to
adjust raking width.**

**Adjustable hitch
with a hitch pin**



**13" spread difference for front
rake hook-up to adjust raking width**

- » This new style has more adjustments!
- » Features center pivot on rear of hitch to better manage your corners!

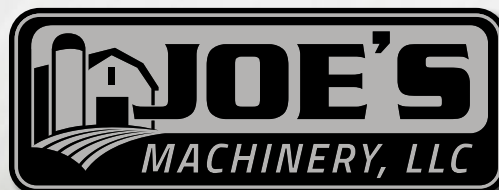

**Available
in steel or
rubber wheels**

717. 464 .1043 » 259 Radcliff Rd. » Willow Street, PA 17584

TANDEM RAKE HITCHES

Heavy-Duty Built

Pictured with old style hitch.



Durable to use and easy to store!

- » Use to hook two New Holland hay rakes together

Whether you want to rake your hay the same way out, or windrow it to the middle, this is the machine!

- » To windrow to the middle, you need a LH258 and RH260 rake
- » To windrow one way out, you can use any 56, 256 or 258

***A great way to save time when raking hay!
Durable and easy to store!***

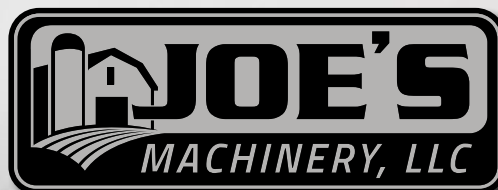

717.464.1043 » 259 Radcliff Rd. » Willow Street, PA 17584

Manufactured in Lancaster County, PA

RED STAR BALE SPEARS

Manufactured by Joe's Machinery

An Easy Way to Move Round or Big Square Bales!

Many More Sizes Available Upon Request!

- » 3 point or skidloader attachments available
- » 1, 2, 3, or 4 prongs – specify which you want
- » Available with 39" or 49" prongs

Not intended for any use except for hay and straw bales.

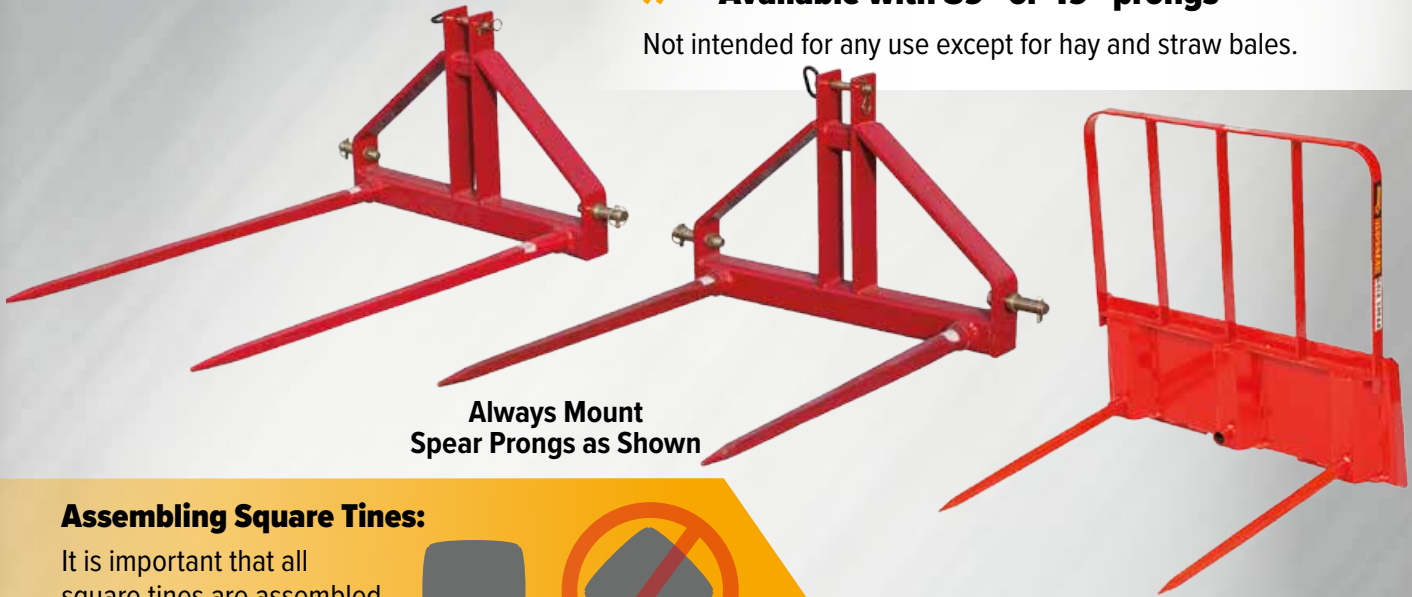

Always Mount Spear Prongs as Shown

Assembling Square Tines:

It is important that all square tines are assembled as shown here



Right



Wrong

NOTE: Nut must be tightened periodically

Always measure from here to here.

Most forklifts will measure either 16", 20", or 24".



Forklift Bale Spear Attachment Bars

Available with or without spears

PART NO.	DESCRIPTION	PRICE
JM80662	Skidloader Mount 2 Prong, 39" H.D.	\$690.00
JM80663	Skidloader Mount 2 Prong, 49" H.D.	\$710.00
JM80664	3 Pt., 2 Prong, 39" H.D.	\$550.00
JM80665	3 Pt., 2 Prong, 49" H.D.	\$570.00
JM80666	HD 1 $\frac{3}{4}$ x 39" Bale Spear Prong	\$94.15
JM80670	HD 1 $\frac{3}{4}$ x 39" Bale Spear Prong Sleeve	\$15.00
JM80667	HD 1 $\frac{3}{4}$ x 49" Bale Spear Prong	\$104.25
JM80670	HD 1 $\frac{3}{4}$ x 49" Bale Spear Prong Sleeve	\$15.00

The 2 sleeves fit both prongs (1 $\frac{3}{4}$)

PART NO.	DESCRIPTION	PRICE
JM80661	Forklift Bale Spear Attachment Bars Without Spears	\$289.00 per pair.

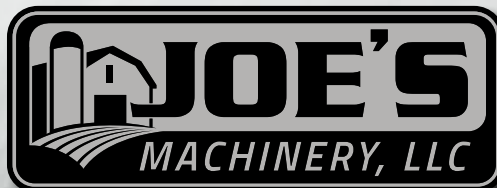

We Can Ship Anything in the Bale Spear Lineup via UPS or 9-5!

717.464.1043 » 259 Radcliff Rd. » Willow Street, PA 17584



Bagger

**...a faster, heavier,
better bagger!**

Seal your profits!



Our **Bagger** is uniquely designed for high-volume bagging, and accommodates a wide variety of crops. Our **Bagger** is available in 6, 8, 9, & 10 feet. In most cases, our **Bagger** will keep up with a 12-row chopper!

Conveyor Features

The extra-wide conveyor has tapered sides and slat belting for fast, easy unloading. Our bagger has handy hydraulic, adjustable flow divider for greater speed.



NEW

*Drag mat for better
density per foot!
A better pack!*

Conveyor Hydraulics

Hydraulic cylinder slide and tilt the conveyor for your convenience. As soon as your wagon or cart is empty, simply pull the hydraulic lever, and bring the conveyor in! No more crashing into the conveyor!



717.464.1043 » 259 Radcliff Rd. » Willow Street, PA 17584

Manufactured in Lancaster County, PA

Hydraulic Features

A 30-gallon hydraulic reservoir tank with cooling pipes eliminates the hot oil. A hydraulic pump runs off the main drive line, including a flow divider for speed adjustments and 2 spool valve levers: one to slide the conveyor, and the other to tilt the conveyor.

Optional: Controls to tractor (order separately)



Hydraulic Self-Contained System

The hydraulics are all self-contained for hassle-free operation. Just place the bag on, engage the PTO, operate the hydraulic levers, *and you are bagging!*

Customer Testimonials

"There is no bagger or blower on the market that is as user-friendly, and unloads as fast as this bagger."

- Jerome Rhoads, PA

"I am very impressed with the simplicity of this machine. You can rent it out, or operate it yourself."

- Ray's Repair, IN

Rubber Tires

Rubber tires are rated at 65 MPH. At this speed, the bagger still tows...just like a trailer.



Disc Brakes

The disc brakes are featured with a hand pump for perfect adjustment, so the wheels do not slide. You can also use an adjustable rod on your tractor brakes to assist with bagger brakes.



Packer Auger

Our packer auger juts out the back of the bagger and tapers down to allow the feed to release off the taper for a smooth finish, and a completely full bag. *No back stop is needed!*



Bag Pan Feature

A hinged bag pan drops down and a bungee rope snaps loose for easy bag loading.



Lights

Standard lighting features include steady tail lights, blinking tail lights, and turning signal lights.

Optional: Work lights



Bag Storage Platform

A large platform is provided for convenient bag and PTO storage. It offers plenty of space for whatever you need.





REDSTAR

Bagger

...a faster, heavier, better bagger!

Seal your profits!

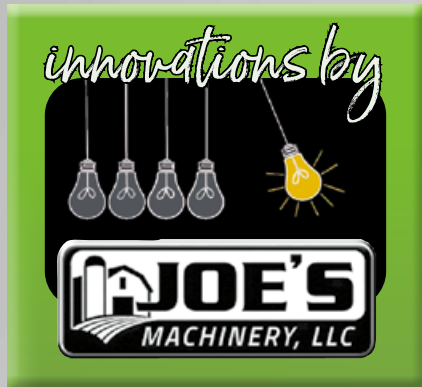

Bagger Models:

6730 6-ft. bagger

8730 8-ft. bagger

9730 9-ft. bagger

1030 10-ft. bagger

Options: (available on all bagger models)

- » Work lights
- » Hydraulic controls to tractor
- » Bag cradle & boom
- » Clamp-on quick-attach tunnel
- » Rubber mat for more consistent packing

Call for more information.



Long Auger

A very heavy-duty auger! Large enough to eliminate "juicing" that occurs during feeding. This auger does not "chew up" silage while packing, which assures you a higher quality feed. *It is proven by feed salespersons!* When running above 175 HP, use 1,000 RPM PTO. For the best packing results, we recommend 2,000 RPM. When running at 540 RPM, simply throttle to PTO speed.



Drive System

Our drive system is heavy-duty built, and made for 250 plus horse power. The Double 80 USA-made chain assures you to pack silage...all you want!



PART NUMBER	PG.						
JM10	34	JM122522	64	JM134921	61	JM139153	30
JM10	146	JM122604	67	JM136137	61	JM139349	34
JM100	3	JM122718	64	JM136544	61	JM139349	39
JM101	3	JM122956	70	JM136545	61	JM139842	34
JM1022606	138	JM122956	101	JM136554	61	JM139843	36
JM1022620	139	JM12330	127	JM136638	30	JM14137A	125
JM1022621	139	JM12334	127	JM136639	30	JM141492	85
JM1025520	139	JM124160	51	JM136642	30	JM14276	127
JM1025521	139	JM12485	128	JM136684	70	JM143024	30
JM103243	70	JM126003	70	JM136684	101	JM143096	36
JM103244	84	JM126219	64	JM136696	70	JM143467	34
JM105259	70	JM126760	64	JM136740	44	JM143469	34
JM110660	70	JM126761	138	JM136771	84	JM143479	65
JM110680	70	JM126761	139	JM136801	84	JM143479	71
JM116311	3	JM127025	11	JM136801	101	JM143517	10
JM116311	36	JM127033	3	JM13686	125	JM143600	14
JM120041	56	JM127037	3	JM136908	140	JM143615	3
JM12084	46	JM127042	3	JM136909	84	JM143616	3
JM12084	48	JM127042A	3	JM136909	101	JM143617	3
JM121092	56	JM127610	3	JM136912	83	JM143760	56
JM12124	63	JM127637	21	JM136919	84	JM144463	21
JM12124	70	JM127820	21	JM136920	84	JM144466	21
JM12124	84	JM128375	70	JM136978	70	JM144523	21
JM12124	101	JM128375	84	JM136978	84	JM14463681	39
JM121506	63	JM128840	64	JM136989	138	JM146258	46
JM121506	124	JM129295	21	JM137129	18	JM146258	48
JM121602	50	JM130585	10	JM137203	29	JM146258	50
JM121602	56	JM131354	64	JM137264	83	JM15112	125
JM121831	21	JM131356	64	JM137388	84	JM15123	125
JM121961	63	JM131491	64	JM137389	85	JM15245	127
JM121969	63	JM131673	61	JM137930	65	JM163641	15
JM122288	63	JM131867	64	JM137930	71	JM163641	22
JM122288A	63	JM131907	64	JM137931	65	JM164012	63
JM122296	63	JM131976	64	JM13818	14	JM164936	56
JM122397	63	JM131998	64	JM138728	46	JM165354	65
JM122397	70	JM131998	84	JM138728	48	JM165354	138
JM122397	84	JM132027	3	JM138741	46	JM165384	65
JM122397A	84	JM132709	10	JM139019	30	JM165419	29
JM122418	63	JM132709	48	JM139034	36	JM165484	22
JM122420	63	JM132709	126	JM139047	36	JM165584	85
JM122432	84	JM132710	10	JM139050	34	JM165584	101
JM122456	63	JM132710	48	JM139052	34	JM165585	85
JM122459	63	JM132710	124	JM13911	71	JM165585	101
JM122469	70	JM132759	84	JM139112	34	JM166258	124
JM122469	84	JM132898	64	JM139116	34	JM166300	65
JM122474	63	JM132898	70	JM139125	30	JM166300	85
JM122476	70	JM13400	48	JM139125A	30	JM16667	128
JM122503	70	JM134142	21	JM139125A	39	JM16754	128
JM122506	64	JM134182	21	JM139125B	30	JM169670	56
JM122506	84	JM134186	19	JM139138	30	JM169703	85
JM122510	64	JM134262	30	JM139138A	39	JM172197	3
		JM134526	61	JM139141	30	JM172204	11

REPLACEMENT PART NUMBER INDEX

PART NUMBER	PG.						
JM172208	3	JM200-1875	140	JM225083	86	JM242999	29
JM172390	10	JM200-2600	140	JM225387	86	JM243120	88
JM172391	10	JM200-3500	140	JM225387	101	JM243121	88
JM172395	10	JM200-4400	140	JM225387	113	JM243157	72
JM172396	10	JM200-5500	140	JM225396	86	JM243465	101
JM172397	10	JM2005500	139	JM225396	101	JM243725	88
JM172433	10	JM2016	125	JM225481	86	JM244169	88
JM172434	10	JM203KRR2	125	JM225482	87	JM244170	88
JM172438	3	JM20401708	44	JM225614	123	JM244179	88
JM172856A	31	JM204041	31	JM225678	87	JM244180	89
JM17415	128	JM204041	39	JM225678	101	JM244245	72
JM174232	3	JM204326	22	JM225679	87	JM244245	89
JM174633	22	JM205KRRB2	125	JM225679	101	JM244246	89
JM174980	85	JM208963	10	JM225915	29	JM244247	89
JM177000	18	JM21	146	JM225925	65	JM244248	89
JM178677	3	JM213565	71	JM226079	87	JM244271	4
JM179462	65	JM214252	29	JM226196	71	JM244273	4
JM179469	65	JM214419	65	JM226196	101	JM244379	89
JM179470	65	JM214539	50	JM226870	22	JM244638	50
JM179470	71	JM214784	85	JM227247	29	JM244638	89
JM179483	65	JM215855	22	JM227794	87	JM244770	83
JM179483	85	JM216294	22	JM228016	87	JM245201	89
JM179492	34	JM216426	18	JM228017	87	JM24527P	138
JM179541	85	JM216447	18	JM228430	4	JM245743	72
JM179923	65	JM216497	22	JM228431	4	JM245743	89
JM179965	71	JM216850	71	JM229542	72	JM24623P	138
JM181991	10	JM216933	18	JM229751	87	JM24624P	139
JM181991	31	JM216966	19	JM229928	87	JM24625P	138
JM181991	36	JM216973	65	JM22R	146	JM24626P	138
JM181991	39	JM218	4	JM230-240	44	JM24723P	138
JM182196	31	JM218230	46	JM234567	46	JM24724P	139
JM183999	65	JM218230	50	JM234567	48	JM247911	22
JM183999	71	JM218983	71	JM234569	66	JM24904	128
JM184347	15	JM22	146	JM237257	87	JM249128	89
JM185746	85	JM223316	85	JM237262	87	JM249845	66
JM187065	31	JM224245	47	JM237273	83	JM25	146
JM18720T	127	JM224265	85	JM237274	83	JM252371	18
JM189168	85	JM224270	85	JM237519	66	JM252653	22
JM189392	71	JM224354	85	JM237521	87	JM25283	46
JM189785	15	JM224355	86	JM237805	87	JM253110	66
JM189785	22	JM224355	101	JM237805	101	JM253162	66
JM195640	48	JM224392	86	JM238158	87	JM253168	72
JM196102	18	JM224400	86	JM238159	87	JM253187	66
JM196287	71	JM224420	86	JM238160	88	JM253434	66
JM197297	44	JM224424	86	JM238163	88	JM253768	72
JM197631	51	JM224427	86	JM238166	88	JM254073	89
JM199954	124	JM224435	86	JM238321	88	JM254132	21
JM200-0600	140	JM224556	124	JM24	146	JM254146	72
JM200-0675	140	JM224644	86	JM241375	66	JM254297	66
JM200-1200	140	JM224775	86	JM242307	88	JM254297	72
JM200-1400	140	JM224895	71	JM242715	88	JM254411	66
		JM224924	86	JM242716	88	JM255097	89

PART NUMBER	PG.						
JM25520C	126	JM280340	90	JM29875	4	JM35948	34
JM25520T	127	JM280369	23	JM32383	31	JM35949	34
JM255649	22	JM280420	10	JM32383	34	JM36139	41
JM25577	125	JM280431	10	JM32431	14	JM362	146
JM25580	125	JM280462	10	JM325	146	JM36312	73
JM25590	125	JM280499	90	JM325424	56	JM36313	46
JM256-258	34	JM280567	44	JM32809	73	JM36313	48
JM256-258	34	JM280656	72	JM330760	56	JM36314	73
JM257102	66	JM280656	90	JM332	127	JM36314	90
JM257260	89	JM280656	102	JM33212	46	JM36622	73
JM25769	44	JM280667	4	JM33212	48	JM36723C	4
JM257702	34	JM280700	72	JM33212	50	JM36723C	34
JM258	31	JM280700	90	JM33358	39	JM36723C	36
JM25821C	126	JM280700	102	JM33469	39	JM36723C	126
JM25821T	127	JM280732	72	JM33781	31	JM36723T	4
JM258452	4	JM280732	102	JM33781	39	JM36723T	10
JM258454	4	JM280744	31	JM33829	39	JM36723T	46
JM25877	125	JM28110	72	JM33856	39	JM36723T	48
JM258S	31	JM28114	72	JM33914	31	JM36723T	50
JM26096	46	JM2820	126	JM33915	40	JM36723T	126
JM261798	66	JM2820	127	JM33942	40	JM36724C	36
JM261958	22	JM28256	72	JM33943	15	JM36724C	124
JM263736	22	JM28280	15	JM33943	40	JM36724T	10
JM263738	22	JM283594	23	JM33967	40	JM36724T	124
JM26382	46	JM284062	29	JM33967A	40	JM36725C	36
JM263840	83	JM284063	29	JM33968	40	JM36725C	126
JM264000	83	JM285072	102	JM33975	40	JM36725T	10
JM264871	23	JM285333	66	JM33979	40	JM36725T	67
JM265351	90	JM285585	44	JM34019	40	JM36725T	126
JM265352	90	JM285667	23	JM34025	32	JM36726C	5
JM26558	72	JM285836	73	JM34030	34	JM36726C	34
JM26616	4	JM285836	90	JM34032	40	JM36726C	36
JM268339	116	JM285879	23	JM34033	40	JM36726C	124
JM269060	56	JM285969	23	JM34039	40	JM36726T	5
JM269975	116	JM286078	23	JM34040	40	JM36726T	10
JM269975B	116	JM286527	67	JM34041	40	JM36726T	124
JM271689	101	JM287066	126	JM34046	40	JM36951	5
JM272688	72	JM287370	46	JM34048	41	JM36989	5
JM272730	56	JM287370	48	JM34057	41	JM370008	56
JM27276	90	JM288799	61	JM34058	41	JM37185	73
JM2735X	127	JM288875	56	JM34065	41	JM37185	90
JM27503	90	JM289416	23	JM34067	41	JM37185	102
JM275246	56	JM28966	39	JM34080	41	JM3720	127
JM27696	102	JM289671	34	JM340853	128	JM373	146
JM27767	90	JM29215	138	JM342A	125	JM375	146
JM27767	102	JM29522P	140	JM348	146	JM377S10	147
JM2788	125	JM29710	127	JM35116	67	JM377S6	147
JM280112	36	JM29790	11	JM352541	128	JM377S8	147
JM280119	46	JM29840	15	JM355	146	JM37857	73
JM280119	48	JM29840	61	JM35664	67	JM379	147
JM280293	4	JM29860	15	JM35664	73	JM380	147
		JM29860	61	JM35664	90	JM381-6	147

REPLACEMENT PART NUMBER INDEX

PART NUMBER	PG.						
JM381-7	147	JM42423	133	JM46992	41	JM48329	42
JM3818	15	JM42424	133	JM470380	128	JM49658	69
JM382	147	JM42425	133	JM470625	128	JM49683	57
JM382A	126	JM42436	133	JM47066	57	JM49683	91
JM382A	127	JM42447	90	JM47066	123	JM49684	91
JM383	147	JM42973	46	JM471192	128	JM501349	125
JM3834	15	JM43048	50	JM471413	128	JM52212	17
JM38391	5	JM43048	73	JM471413	128	JM52443	123
JM384	147	JM43048	90	JM471652	128	JM52736	50
JM385	147	JM43090015	102	JM471737	128	JM528526	102
JM385-12	147	JM43138	57	JM47204	91	JM529	149
JM386510	56	JM43140	57	JM47216	16	JM530	149
JM386511	56	JM43260	57	JM472164	128	JM54695	62
JM38766	50	JM434	148	JM472258	128	JM55	42
JM38766	56	JM436B	148	JM472439	128	JM56-0600	141
JM38766	123	JM436L	148	JM472924	128	JM56-0844	141
JM387A	125	JM436R	148	JM473227	128	JM56-1600	141
JM392	5	JM440	148	JM473231	128	JM56-2000	141
JM39271	41	JM445	148	JM473237	128	JM56-2101	141
JM39360	34	JM44643	125	JM473239	128	JM56-2102	141
JM39360	36	JM44788	44	JM473313	128	JM56-2122	141
JM39361	41	JM44914	48	JM474278	128	JM56-2200	141
JM395R	148	JM452	148	JM47471	51	JM56-2223	141
JM39665	5	JM453	148	JM47577168	61	JM56-2324	141
JM40293	90	JM45440	102	JM47618652	57	JM56-2600	141
JM408	10	JM455456	5	JM47618652	62	JM56-4103	141
JM408	148	JM456	5	JM47618652	113	JM56-6105	141
JM40974	102	JM456PA	5	JM481181	128	JM56-6106	141
JM412674	57	JM45882	50	JM48138	31	JM56-8108	141
JM42019	90	JM46047	73	JM48138A	31	JM56482	16
JM420R	148	JM461	148	JM48149	31	JM56704	67
JM421L	148	JM462	148	JM48155	32	JM56704	102
JM42301	132	JM46442	67	JM48173	36	JM570384	23
JM42306	132	JM46443	67	JM48174	36	JM572421	50
JM42334	132	JM46443	91	JM48176	36	JM572734	50
JM42335	132	JM46520	16	JM48180	36	JM572735	50
JM42336	132	JM46520	50	JM48185	36	JM572735A	44
JM42336	135	JM46520	73	JM48191	36	JM572891	50
JM42337	132	JM46520	91	JM48191	41	JM572893	51
JM42338	132	JM46520	102	JM48198	46	JM572894	50
JM42339	132	JM46566	91	JM48198	48	JM573376	23
JM42350	132	JM467820	73	JM48198	50	JM573453	44
JM42351	132	JM46789	67	JM48198	124	JM574171	67
JM42352	132	JM46810	57	JM482	148	JM574171	73
JM42353	132	JM46826	20	JM48219	32	JM574245	44
JM42356	133	JM46826	67	JM48253	34	JM575246	23
JM42357	133	JM46826	73	JM48281	34	JM575988	73
JM42358	133	JM46876	5	JM48282	34	JM576253	57
JM42359	133	JM46876	34	JM48283	34	JM577867	20
JM42370	133	JM46889	67	JM48315	32	JM577900	29
JM42371	133	JM46988	41	JM48316	32	JM578189	50
		JM46991	41	JM48329	32	JM578727	73

PART NUMBER	PG.						
JM578738	74	JM616414	50	JM63782	14	JM644102	46
JM578743	74	JM616780	32	JM637895	104	JM644107	50
JM578788	91	JM616S	149	JM63797	14	JM644199	48
JM578790	74	JM618086	48	JM63798	14	JM644201	46
JM578801	74	JM618966	46	JM63800	6	JM644201	48
JM578806	74	JM618966	48	JM63802	14	JM644202	46
JM578826	74	JM618966	50	JM63805	14	JM644463	51
JM579364	74	JM619104	91	JM63806	14	JM644465	48
JM579497	24	JM619107	91	JM63815	6	JM644466	48
JM579925	46	JM619208	91	JM63828	6	JM644469	48
JM579925	48	JM619208	103	JM638297	75	JM644470	50
JM58106	24	JM619226	92	JM63839	14	JM644474	46
JM58118	74	JM619248	44	JM63841	14	JM644474	50
JM58118	91	JM619288	92	JM63843	10	JM644515	46
JM595512	109	JM620490	92	JM63848	10	JM644515	48
JM5C0440LLC3	125	JM6207-2NSE9	125	JM63867	6	JM644591	46
JM6	146	JM620A	46	JM63869	6	JM644595	48
JM600	149	JM6210-2NSE9	126	JM63871	6	JM644894	50
JM600368	83	JM621425	74	JM63881	6	JM644895	50
JM600486	102	JM621425	92	JM63881	10	JM644973	50
JM600488	102	JM623582	92	JM63881A	6	JM644974	51
JM6010-2RS	125	JM626183	19	JM639	149	JM645115	44
JM601109	91	JM627384	74	JM63904A	6	JM645120	45
JM601109	102	JM627387	74	JM63905	6	JM645124	45
JM602641	74	JM627631	92	JM639108	104	JM645145	46
JM60289	149	JM6307-2RS	126	JM639328	48	JM645145	48
JM602996	74	JM63086	32	JM639338	104	JM645212	46
JM603	149	JM63106	29	JM639338	113	JM645215	48
JM603373	10	JM632289	92	JM639349	104	JM645218	48
JM603917	91	JM632290	92	JM639349	113	JM645222	48
JM604016	91	JM632649	103	JM639766	104	JM645266	46
JM60489	149	JM633389	103	JM639787	104	JM645365	46
JM605	149	JM633395	103	JM640091	75	JM645433	46
JM605170	48	JM634783	19	JM640148	48	JM645433	48
JM605171	48	JM634994	138	JM640220	104	JM645614	48
JM605205	11	JM635411	92	JM640291	104	JM645618	46
JM606352	91	JM63586	16	JM64053	46	JM64562	32
JM607L	149	JM636324	103	JM64053	50	JM645848	45
JM60989	149	JM636475	103	JM64126	6	JM645870	45
JM610S	149	JM636475	113	JM64126A	7	JM645962	45
JM611	149	JM636777	103	JM64127	7	JM645963	45
JM611447	67	JM636777A	103	JM641627	32	JM646010	45
JM611785	50	JM63725	5	JM641630	104	JM646056	75
JM612	149	JM637464	104	JM641777	105	JM646360	46
JM612377	24	JM637465	104	JM641777	113	JM646361	45
JM612408	20	JM63752	5	JM642360	105	JM646362	45
JM613	149	JM63753	6	JM642361	112	JM646418	45
JM614082	103	JM63762	6	JM642366	105	JM646455	52
JM614084	103	JM63771	6	JM642371	105	JM646523	48
JM614671	24	JM63777	6	JM642371	113	JM646524	46
JM615546	103	JM63777A	6	JM64353	7	JM646525	46
		JM63778	14	JM644100	46	JM646549	52

REPLACEMENT PART NUMBER INDEX

PART NUMBER	PG.				
JM646602	52	JM676240	113	JM692916	7
JM646614	52	JM676900	105	JM692917	7
JM646615	52	JM676997	105	JM69310	126
JM646694	32	JM676997	113	JM694005	50
JM646755	52	JM677563	75	JM697394	106
JM646756	52	JM677563	105	JM697395	106
JM646757	52	JM677847	36	JM697396	106
JM646795	52	JM677847	42	JM697397	106
JM646796	52	JM678422	46	JM698154	48
JM646797	52	JM678424	48	JM700035	24
JM646903	47	JM678615	105	JM700411	75
JM646903	52	JM678617	105	JM700493	75
JM646904	52	JM678619	105	JM700685	93
JM646905	52	JM678621	105	JM700758	93
JM646942	53	JM678626	105	JM700905	75
JM646966	53	JM678687	48	JM700914	75
JM647876	24	JM678912	106	JM701316	75
JM648844	19	JM680728	53	JM701317	75
JM64972	34	JM680729	46	JM701519	46
JM649D	150	JM68149	126	JM701519	48
JM649F	150	JM681678	45	JM701519	75
JM649R	150	JM682360	75	JM701562	24
JM65234	9	JM682360	106	JM701593	93
JM65518	7	JM682361	75	JM702034	76
JM65548	10	JM682361	106	JM702209	93
JM655892	92	JM685133	46	JM702743	76
JM65705	7	JM685291	46	JM702847	76
JM65790	16	JM685291	48	JM703244	76
JM65792	16	JM685461	47	JM703727	76
JM65804	7	JM685461	50	JM703728	76
JM65812	16	JM685462	51	JM703784	76
JM65845	7	JM686388	47	JM703995	62
JM65930	34	JM686389	47	JM703996	62
JM65930	92	JM686539	75	JM704386	32
JM65931	16	JM686583	105	JM704580	76
JM66460	75	JM686730	47	JM704580	93
JM66460	92	JM688048	67	JM704585	93
JM66480	16	JM688398	48	JM705116	24
JM66553	46	JM688963	106	JM705117	24
JM66553	48	JM689165	24	JM705279	93
JM66553	75	JM69-0648	141	JM705279	106
JM66553	93	JM69-1248	141	JM705854	93
JM66595	93	JM69-2248	141	JM705855	93
JM66807	93	JM69-2648	141	JM706617	93
JM66967	57	JM690222	106	JM706646	93
JM67015	32	JM690225	106	JM706712	93
JM67048	126	JM690226	106	JM706736	94
JM67372	67	JM690503	50	JM706739	94
JM67437	10	JM691097	50	JM706740	94
JM675355	47	JM691100	50	JM706741	94
JM676230	113	JM692300	46	JM706742	94
		JM692300	48	JM707373	50
				JM707374	50
				JM707750	32
				JM707854	94
				JM708756	46
				JM708756	48
				JM709063	24
				JM709318	63
				JM709971	94
				JM710014	94
				JM710450	76
				JM710984	76
				JM712067	94
				JM713229	76
				JM713549	94
				JM713551	76
				JM713551	94
				JM713555	94
				JM714504	106
				JM714504	113
				JM715034	94
				JM715357	107
				JM715499	95
				JM715782	76
				JM715964	95
				JM716163	76
				JM716164	77
				JM716321	95
				JM716325	95
				JM717-718	67
				JM718013	32
				JM718478	95
				JM718556	67
				JM719026	95
				JM719220	95
				JM719563	50
				JM719563	57
				JM719565	50
				JM76031	36
				JM762790	107
				JM762836	75
				JM762836	105
				JM763026	24
				JM763338	50
				JM763883	25
				JM764347	25
				JM764785	77
				JM764892	25
				JM76516	25
				JM76517	19
				JM767247	10
				JM767618	128
				JM768235	77

REPLACEMENT PART NUMBER INDEX

PART NUMBER	PG.						
JM768235	107	JM80100	8	JM80310	96	JM8056	33
JM768236	77	JM80101	9	JM80311	96	JM8057	33
JM768236	107	JM80102	9	JM80312	96	JM80577868	20
JM768239	95	JM8010A	8	JM80313	96	JM80579116	26
JM768242	77	JM8011	8	JM8032	12	JM8057A	33
JM76877	95	JM8012	8	JM8033	12	JM8058	33
JM768987	95	JM80120	16	JM803348	107	JM8059	33
JM770942	19	JM80121	16	JM8034	12	JM806	150
JM771820	107	JM80122	16	JM8035	14	JM8060	33
JM772028	25	JM80123	17	JM8036	15	JM8061	33
JM774773	50	JM80124	17	JM8037	15	JM8061A	33
JM7770	36	JM8012A	8	JM8038	15	JM8062	33
JM782446	50	JM8012B	8	JM8039	17	JM8063	38
JM782447	50	JM8012C	8	JM804	150	JM8064	38
JM782590	25	JM8013	9	JM8040	17	JM8065	34
JM782790	77	JM80138243	78	JM80400	99	JM8065	38
JM78279010	77	JM80138243	107	JM80401	99	JM80650	43
JM784239	77	JM8014	9	JM80402	99	JM80651	43
JM784240	77	JM8015	9	JM80403	99	JM80652	43
JM784247	77	JM8016	9	JM80404	99	JM80653	43
JM784248	77	JM8016A	9	JM80405	99	JM80654	43
JM784540	77	JM8017	9	JM80406	99	JM80655	43
JM784651	77	JM8017A	9	JM80407	99	JM80656	43
JM784652	78	JM8018	9	JM80408	99	JM80657	43
JM784858	10	JM8019	9	JM80409	99	JM80658	43
JM784859	10	JM802	150	JM80410	99	JM80660	43
JM784964	78	JM8020	9	JM80411	99	JM80661	162
JM786144	78	JM80201	25	JM80412	100	JM80662	162
JM786489	78	JM80202	25	JM80413	100	JM80663	162
JM791531	78	JM8021	12	JM80414	100	JM80664	162
JM791531	95	JM8022	12	JM80415	100	JM80665	162
JM791531	107	JM80223439	68	JM80416	100	JM80666	162
JM792493	32	JM8023	12	JM80417	100	JM80667	162
JM796353	107	JM8023AB	12	JM80418	100	JM8067	53
JM796623	78	JM8023BN	12	JM8042	12	JM80670	162
JM796624	78	JM8024	12	JM8042	19	JM80670	162
JM798096	78	JM8027	12	JM8043	25	JM80679	10
JM8	146	JM8028	12	JM8044	25	JM80679	10
JM800	150	JM80289488	20	JM8045	26	JM80679	10
JM8000	7	JM8029	12	JM8046	33	JM8068	57
JM8001	7	JM8029	19	JM8047	33	JM80680	46
JM8002	7	JM803	150	JM8047	34	JM80682	36
JM8003	8	JM8030	12	JM8048	36	JM80682	36
JM8004	8	JM8030	19	JM8048T	36	JM8069	62
JM8005	8	JM80303	68	JM8049	33	JM807	150
JM8006	8	JM80304	68	JM805	150	JM8070	66
JM8007	8	JM80305	93	JM8050	33	JM80700464	78
JM8008	8	JM80306	95	JM8051	33	JM8071	68
JM8009	8	JM80307	95	JM8052	33	JM80711	34
JM801	150	JM80308	95	JM8053	33	JM80711	36
JM8010	8	JM80309	95	JM8054	33	JM8072	68
		JM8031	12	JM8055	33	JM80753	96

REPLACEMENT PART NUMBER INDEX

PART NUMBER	PG.						
JM80754	10	JM8086	96	JM850613	38	JM86517279	108
JM80754	12	JM8087	96	JM850614	38	JM86518367	80
JM80754	50	JM8088	96	JM850735	79	JM86520197	58
JM80756	11	JM8089	96	JM851697	107	JM86521513	108
JM8076	78	JM8089A	96	JM851709	79	JM86523991	42
JM80765	42	JM809	150	JM851709	107	JM86527961	13
JM80768	34	JM8090	96	JM851709	113	JM86528220	26
JM80768	48	JM80906	116	JM851797	79	JM86528652	79
JM8077	78	JM80908	116	JM853616	107	JM86528652	97
JM80781	36	JM8091	96	JM853905	79	JM86528652	108
JM8078LH	78	JM80910	116	JM854233	112	JM86528900	58
JM8078RH	78	JM8092	96	JM854381	107	JM86528913	58
JM8079	79	JM8098	113	JM854415	62	JM86536196	126
JM80793	38	JM810	150	JM854416	62	JM86536275	62
JM808	150	JM811	150	JM855838	138	JM86536900	57
JM8080	92	JM812	151	JM856130	138	JM86537848	36
JM80800	117	JM813	151	JM856144	46	JM86541779	10
JM80801	117	JM81305	68	JM856146	46	JM86547234	114
JM80802	117	JM814	151	JM856197	83	JM86548300	116
JM80803	118	JM815	151	JM856297	57	JM86550248	58
JM80804	118	JM818	151	JM856379	57	JM86551519	114
JM80805	118	JM819	151	JM857262	79	JM86558574	68
JM80806	118	JM820	151	JM857264	79	JM86558574	80
JM80807	118	JM821	151	JM857758	79	JM86559854	114
JM80808	118	JM822	151	JM858740	12	JM86575514	17
JM80809	118	JM823	151	JM858834	116	JM86575514	26
JM8081	83	JM824	151	JM859106	108	JM86575566	114
JM80810	118	JM825	152	JM859331	80	JM86579851	139
JM80811	118	JM828	152	JM859687	57	JM8658801	61
JM80812	118	JM830	152	JM8603209	57	JM86591668	81
JM80813	118	JM832	152	JM86052	10	JM86593050	80
JM80814	118	JM834	152	JM86052	124	JM86593056	97
JM80815	118	JM835	152	JM86500943	57	JM86598202	108
JM80816	119	JM836	152	JM86500945	58	JM86598202	114
JM80817	119	JM837	152	JM86503333	13	JM86613003A	109
JM80818	119	JM838	152	JM86507377	20	JM86615412	114
JM80819	119	JM839	152	JM86508155	21	JM86616989	20
JM8082	83	JM840	152	JM86509454	79	JM86616990	20
JM80820	119	JM841	152	JM86510024	116	JM86617059	20
JM80821	119	JM842	153	JM86511191	36	JM86617060	20
JM80822	119	JM843	153	JM86511977	97	JM86617061	20
JM80823	119	JM84389548	12	JM86511977	108	JM86618727	114
JM80824	119	JM844	153	JM86512015	124	JM86620027	17
JM80825	119	JM845	153	JM86512516	114	JM86620027	26
JM80826	119	JM846	153	JM865145	48	JM86620027	108
JM80827	119	JM84913	42	JM86514713	108	JM86620779	80
JM80828	119	JM84944	46	JM86514714	108	JM86620779	108
JM80829	119	JM850	153	JM86515794	79	JM86620779	116
JM8083	83	JM850079	79	JM86516467	10	JM86620781	116
JM80830	119	JM850136	26	JM86516467	126	JM86621454	80
JM8085	96	JM850137	12	JM86516721	79	JM86621454	117
		JM850612	38	JM86517158	108	JM86621455	117

REPLACEMENT PART NUMBER INDEX

PART NUMBER	PG.						
JM86621578	58	JM86635892	109	JM87381	36	JM9007	122
JM86621580	58	JM86635892	115	JM87395	36	JM9008	122
JM86621657	55	JM86635893	109	JM87395	36	JM9009	122
JM86622143	80	JM86635893	115	JM87395	46	JM9010	122
JM86622143	108	JM86635908	97	JM87395	50	JM9011	123
JM86622174	80	JM86635908	109	JM87414	34	JM9012	123
JM86622174	108	JM86635908H	97	JM87414	34	JM9013	123
JM86622662	13	JM86635909	97	JM87415	10	JM9014C	124
JM86624446	114	JM86635909	109	JM87422066	13	JM9014T	124
JM86624469	20	JM8663591	109	JM87446	46	JM9015	124
JM86624516	58	JM86635910	97	JM87446	50	JM9016	124
JM86624518	58	JM86635911	109	JM87446	97	JM9017	124
JM86624579	58	JM86635935	115	JM87449	27	JM9018	126
JM86625582	26	JM86635936	115	JM87500	27	JM9019	127
JM86627129	59	JM86635943	115	JM87517382	13	JM9020	127
JM86627790	29	JM86635945	115	JM87569	10	JM9021	127
JM86627870	26	JM86635950	115	JM87642989	62	JM9022	127
JM86627930	114	JM86636511	80	JM87658033	97	JM9028	137
JM86629289	27	JM86636511	109	JM87670	48	JM9029	137
JM86629486	68	JM86636512	97	JM87696	97	JM9030	137
JM86631017	27	JM86636606	115	JM87847	68	JM9031	137
JM86631018	27	JM86636614	115	JM87872	36	JM9032	137
JM86631102	27	JM86636978	110	JM87955	97	JM9060	116
JM86631407	97	JM86637313	116	JM87974	34	JM9065	110
JM86631723RH	58	JM86637501	42	JM88107A	126	JM9090	117
JM86631929	55	JM86641949	80	JM88107B	125	JM9601646	110
JM86631930	55	JM86641950	110	JM88182	10	JM9609162	109
JM86631931	55	JM866617759	13	JM88246	80	JM9609440	110
JM86631932	55	JM866617760	13	JM88246	97	JM9609478	110
JM86631939	55	JM86705943	58	JM88338	10	JM9609485	110
JM86632157	114	JM86729275	10	JM88417	68	JM9610638	110
JM86632788	114	JM86837281	20	JM88542	36	JM9610799	80
JM86633047	27	JM86837316	42	JM88551	46	JM9611168	110
JM86633054	17	JM86837895	38	JM88551	48	JM9614489	111
JM86633054	27	JM86837915	34	JM88635	110	JM9614491	111
JM86633666	46	JM86837915	38	JM88682	46	JM9615260	59
JM86633666	48	JM86900802	42	JM88775	36	JM9615266	59
JM86633816	59	JM86900816	97	JM88849	10	JM9615267	59
JM86633840	59	JM86978339	38	JM88849	68	JM9615293	59
JM86635000	115	JM86979736	80	JM88849	80	JM9615294	59
JM86635012	17	JM87013818	13	JM88852	68	JM9616873	80
JM86635012	27	JM87018102	114	JM88864	110	JM9616873	111
JM86635517	109	JM87028576	38	JM88886	36	JM9616874	81
JM86635853	80	JM87053	36	JM88980	51	JM9616875	111
JM86635853	97	JM87054556	97	JM9000	109	JM9617027	111
JM86635853	109	JM87263	46	JM9001	117	JM9617273	111
JM86635877	109	JM87297020	21	JM9002	117	JM9617281	111
JM86635888	109	JM87297021	21	JM9002a	117	JM9617470	59
JM86635888	115	JM87313	10	JM9003	122	JM9617519	111
JM86635889	109	JM87363	11	JM9004	122	JM9617868	69
JM86635889	115	JM87365	46	JM9005	122	JM9617871	13
		JM87365	48	JM9006	122	JM9617912	81

REPLACEMENT PART NUMBER INDEX

PART NUMBER	PG.				
JM9618047	111	JM9822699	60	JM9822699	60
JM9618050	98	JM9824963	81	JM9824963	81
JM9619666	59	JM9825157	60	JM9825157	60
JM9619688	81	JM9825158	60	JM9825158	60
JM9619690	74	JM9827767	48	JM9827767	48
JM9619871	81	JM9827836	81	JM9827836	81
JM9619871	111	JM9827836	98	JM9827836	98
JM9619931	69	JM9827836	112	JM9827836	112
JM9619931	81	JM9827867	60	JM9827867	60
JM9619931	98	JM9827884	60	JM9827884	60
JM9622548	59	JM9827885	60	JM9827885	60
JM9623519	81	JM9828106	60	JM9828106	60
JM9623570	20	JM9841805	139	JM9841805	139
JM9623571	20	JM9842118	54	JM9842118	54
JM9623572	20	JM9842119	54	JM9842119	54
JM9623846	111	JM9842120	54	JM9842120	54
JM9623892	50	JM9842620	112	JM9842620	112
JM9626568	36	JM9842737	36	JM9842737	36
JM9800135	38	JM9842999	112	JM9842999	112
JM9800710	61	JM9843091	112	JM9843091	112
JM9800740	59	JM9843298	60	JM9843298	60
JM9803718	107	JM9843538	60	JM9843538	60
JM9804623	81	JM9845441	60	JM9845441	60
JM9805207	116	JM9846006	62	JM9846006	62
JM9806283	110	JM9846532	83	JM9846532	83
JM9807906	38	JM9847177	101	JM9847177	101
JM9807906	59	JM9847572	62	JM9847572	62
JM9807938	61	JM9847988	60	JM9847988	60
JM980822	59	JM9849886	60	JM9849886	60
JM9808272	59	JM98522P	140	JM98522P	140
JM9808503	59	JM98526P	140	JM98526P	140
JM980907	59	JMAS20090	141	JMAS20090	141
JM9809671	13	JMAS20130	141	JMAS20130	141
JM9809671	98	JMAS20180	141	JMAS20180	141
JM9820509	111	JMAS30090	141	JMAS30090	141
JM9822234	128	JMAS30130	141	JMAS30130	141
JM9822651	60	JMAS30180	141	JMAS30180	141
JM9822696	60	JMAS30180	141	JMAS30180	141
JM9822697	60	JMASW3100	141	JMASW3100	141
		JMASW7100	141	JMASW7100	141
		JMB2812	125	JMB2812	125
		JM9822699	60	JM9822699	60
		JM9824963	81	JM9824963	81
		JM9825157	60	JM9825157	60
		JM9825158	60	JM9825158	60
		JM9827767	48	JM9827767	48
		JM9827836	81	JM9827836	81
		JM9827836	98	JM9827836	98
		JM9827836	112	JM9827836	112
		JM9827867	60	JM9827867	60
		JM9827884	60	JM9827884	60
		JM9827885	60	JM9827885	60
		JM9828106	60	JM9828106	60
		JM9841805	139	JM9841805	139
		JM9842118	54	JM9842118	54
		JM9842119	54	JM9842119	54
		JM9842120	54	JM9842120	54
		JM9842620	112	JM9842620	112
		JM9842737	36	JM9842737	36
		JM9842999	112	JM9842999	112
		JM9843091	112	JM9843091	112
		JM9843298	60	JM9843298	60
		JM9843538	60	JM9843538	60
		JM9845441	60	JM9845441	60
		JM9846006	62	JM9846006	62
		JM9846532	83	JM9846532	83
		JM9847177	101	JM9847177	101
		JM9847572	62	JM9847572	62
		JM9847988	60	JM9847988	60
		JM9849886	60	JM9849886	60
		JM98522P	140	JM98522P	140
		JM98526P	140	JM98526P	140
		JMAS20090	141	JMAS20090	141
		JMAS20130	141	JMAS20130	141
		JMAS20180	141	JMAS20180	141
		JMAS30090	141	JMAS30090	141
		JMAS30130	141	JMAS30130	141
		JMAS30180	141	JMAS30180	141
		JMASW3100	141	JMASW3100	141
		JMASW7100	141	JMASW7100	141
		JMB2812	125	JMB2812	125
		JM9822699	60	JM9822699	60
		JM9824963	81	JM9824963	81
		JM9825157	60	JM9825157	60
		JM9825158	60	JM9825158	60
		JM9827767	48	JM9827767	48
		JM9827836	81	JM9827836	81
		JM9827836	98	JM9827836	98
		JM9827836	112	JM9827836	112
		JM9827867	60	JM9827867	60
		JM9827884	60	JM9827884	60
		JM9827885	60	JM9827885	60
		JM9828106	60	JM9828106	60
		JM9841805	139	JM9841805	139
		JM9842118	54	JM9842118	54
		JM9842119	54	JM9842119	54
		JM9842120	54	JM9842120	54
		JM9842620	112	JM9842620	112
		JM9842737	36	JM9842737	36
		JM9842999	112	JM9842999	112
		JM9843091	112	JM9843091	112
		JM9843298	60	JM9843298	60
		JM9843538	60	JM9843538	60
		JM9845441	60	JM9845441	60
		JM9846006	62	JM9846006	62
		JM9846532	83	JM9846532	83
		JM9847177	101	JM9847177	101
		JM9847572	62	JM9847572	62
		JM9847988	60	JM9847988	60
		JM9849886	60	JM9849886	60
		JM98522P	140	JM98522P	140
		JM98526P	140	JM98526P	140
		JMAS20090	141	JMAS20090	141
		JMAS20130	141	JMAS20130	141
		JMAS20180	141	JMAS20180	141
		JMAS30090	141	JMAS30090	141
		JMAS30130	141	JMAS30130	141
		JMAS30180	141	JMAS30180	141
		JMASW3100	141	JMASW3100	141
		JMASW7100	141	JMASW7100	141
		JMB2812	125	JMB2812	125
		JM9822699	60	JM9822699	60
		JM9824963	81	JM9824963	81
		JM9825157	60	JM9825157	60
		JM9825158	60	JM9825158	60
		JM9827767	48	JM9827767	48
		JM9827836	81	JM9827836	81
		JM9827836	98	JM9827836	98
		JM9827836	112	JM9827836	112
		JM9827867	60	JM9827867	60
		JM9827884	60	JM9827884	60
		JM9827885	60	JM9827885	60
		JM9828106	60	JM9828106	60
		JM9841805	139	JM9841805	139
		JM9842118	54	JM9842118	54
		JM9842119	54	JM9842119	54
		JM9842120	54	JM9842120	54
		JM9842620	112	JM9842620	112
		JM9842737	36	JM9842737	36
		JM9842999	112	JM9842999	112
		JM9843091	112	JM9843091	112
		JM9843298	60	JM9843298	60
		JM9843538	60	JM9843538	60
		JM9845441	60	JM9845441	60
		JM9846006	62	JM9846006	62
		JM9846532	83	JM9846532	83
		JM9847177	101	JM9847177	101
		JM9847572	62	JM9847572	62
		JM9847988	60	JM9847988	60
		JM9849886	60	JM9849886	60
		JM98522P	140	JM98522P	140
		JM98526P	140	JM98526P	140
		JMAS20090	141	JMAS20090	141
		JMAS20130	141	JMAS20130	141
		JMAS20180	141	JMAS20180	141
		JMAS30090	141	JMAS30090	141
		JMAS30130	141	JMAS30130	141
		JMAS30180	141	JMAS30180	141
		JMASW3100	141	JMASW3100	141
		JMASW7100	141	JMASW7100	141
		JMB2812	125	JMB2812	125
		JM9822699	60	JM9822699	60
		JM9824963	81	JM9824963	81
		JM9825157	60	JM9825157	60
		JM9825158	60	JM9825158	60
		JM9827767	48	JM9827767	48
		JM9827836	81	JM9827836	81
		JM9827836	98	JM9827836	98
		JM9827836	112	JM9827836	112
		JM9827867	60	JM9827867	60
		JM9827884	60	JM9827884	60
		JM9827885	60	JM9827885	60
		JM9828106	60	JM9828106	60
		JM9841805	139	JM9841805	139
		JM9842118	54	JM9842118	54
		JM9842119	54	JM9842119	54
		JM9842120	54	JM9842120	54
		JM9842620	112	JM9842620	112
		JM9842737	36	JM9842737	36
		JM9842999	112	JM9842999	112
		JM9843091	112	JM9843091	112
		JM9843298	60	JM9843298	60
		JM9843538	60	JM9843538	60
		JM9845441	60	JM9845441	60
		JM9846006	62	JM9846006	62
		JM9846532	83	JM9846532	83
		JM9847177	101	JM9847177	101
		JM9847572	62	JM9847572	62
		JM9847988	60	JM9847988	60
		JM9849886	60	JM9849886	60
		JM98522P	140	JM98522P	140
		JM98526P	140	JM98526P	140
		JMAS20090	141	JMAS20090	141
		JMAS20130	141		

EQUIPMENT PRODUCTION DATES

Weight of the machine given in lbs. where shown.

Part #	Weight	Dates
--------	--------	-------

MOWERS

NH455.....		7/1962 – 7/1968
NH456.....784	784	7/1969 – present
NH450.....		7/1961 – 7/1968
NH451.....609	609	7/1969 – present

HARVESTERS

NH707.....		7/1972 – 7/1985
NH717.....1,845	1,845	7/1964 – 2/1996
NH718.....2,100	2,100	7/1974 – 2/1996
NH770.....2,300	2,300	7/1982 – 7/1979
NH782.....2,685	2,685	7/1978 – 7/1984
NH790.....2,510	2,510	4/1987 – present
NH890.....2,510	2,510	7/1973 – 7/1980
NH892.....3,475	3,475	7/1978 – 7/1984
NH900.....5,065	5,065	7/1984 – 9/1999
NHFP230.....5,831	5,831	1/2000 – present
NHFP240.....5,831	5,831	9/1999 – present
NH1600	N/A	7/1982 – 7/1986
NH1890	N/A	7/1975 – 7/1978
NH1895	N/A	7/1975 – 7/1982
NH1900	16,815	7/1980 – 7/1988
NH2115	20,119	7/1988 – 6/1995

Part #	Weight	Dates
--------	--------	-------

RAKES

NH55.....870	870	1/1958 – 1/1959
NH56.....		1/1961 – 12/1967
NH256.....		7/1967 – present
NH258.....850	850	10/1994 – 6/2002
NH254.....		7/1985 – 1/1994
NH260.....885	885	7/1967 – present

CRIMPERS

NH401.....		7/1958 – 7/1963
NH402.....		7/1961 – 7/1971

HAYBINES

NH472.....2,506	2,506	7/1979 – present
NH474.....2,512	2,512	7/1979 – 12/1992
NH477.....2,340	2,340	7/1972 – 7/1977
NH478.....2,506	2,506	7/1977 – 7/1977
NH479.....3,000	3,000	7/1972 – 7/1977
NH488.....3,006	3,006	7/1977 – present
NH489.....3,073	3,073	7/1977 – 6/1989
NH492.....3,250	3,250	7/1989 – 6/1996
NH495.....4,290	4,290	7/1975 – 7/1990
NH 824 Cornhead		

FROM:
JOE'S MACHINERY LLC
259 Radcliff Road
Willow Street, PA 17584

Presorted Std.
US Postage
PAID
Lancaster, PA
Permit #1385



TO:

Equipment Rebuilding is Our Specialty

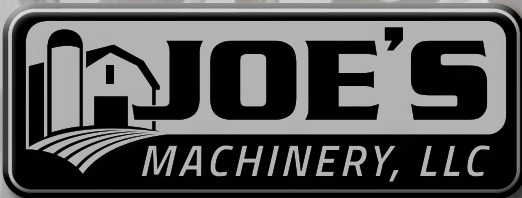

Call anytime
717.464.1043
Mon. through Fri.
Or if nobody answers,
please leave a message.

JOE'S MACHINERY LLC